

## User's Manual for L180 digital servo drive



# MOOG

## L180 User's Manual

---

### Record of Manual Revision

Revision Index	Date	Author	Description	Effectivity
a	13 <sup>th</sup> April. 00	Joachim Heinrich	First Release	All
b	2 <sup>nd</sup> May 00	Joachim Heinrich	Second Release	All
c	4 <sup>th</sup> May 01	Joachim Heinrich	Third Release, including L180GUI 2.0 and firmware A2	All

### Copyright Information

© Copyright 2001 MOOG - All rights reserved

The information contained in this document is the property of MOOG GmbH and may not be reproduced or transmitted in any form or by any means, electronic, mechanical, photocopying, recording or otherwise, nor stored in any retrieval system of any nature without the express written authority of MOOG GmbH.

This manual is periodically reviewed and revised. These instructions have been written and checked to the best of our knowledge and belief. However, MOOG GmbH assumes no responsibility for any errors or omissions in this document. Information in this manual is subject to change without notice and does not represent a commitment on the part the MOOG Corporation.

Microsoft, Windows NT, Windows 95 and Windows 98 are registered trademarks of Microsoft Corporation.

Critical evaluation of the manual is welcomed. Your comments will assist us in future product documentation.

## TABLE OF CONTENTS

<b>1</b>	<b>DESCRIPTION AND TECHNICAL DATA</b>	<b>11</b>
1.1	INTRODUCTION	11
1.1.1	DESCRIPTION	12
1.2	INSTRUCTIONS TO THE MANUAL	13
1.3	TECHNICAL DATA	14
1.3.1	DESIGN STANDARDS	14
1.3.2	MODEL NUMBER SELECTION	15
1.3.3	ACCESSORIES	16
1.3.4	GENERAL DATA	17
1.3.5	ELECTRICAL DATA	18
1.3.5.1	DRIVE RATINGS	18
1.3.5.2	POWER DISSIPATION	18
1.3.5.3	REGENERATION POWER	19
1.3.6	MECHANICAL DIMENSIONS	20
1.3.7	DRIVE OVERVIEW	21
1.3.8	DRIVE NAMEPLATE	22

<b>2</b>	<b>SAFETY INSTRUCTIONS</b>	<b>23</b>
2.1	QUALIFIED PERSONNEL	23
2.2	MAIN SAFETY INSTRUCTIONS	24
2.3	INFORMATION ON EMC	25
<b>3</b>	<b>SERVOMOTORS</b>	<b>27</b>
3.1	MOUNTING AND INSTALLATION	27
3.1.1	MOTOR NAMEPLATE	27
3.1.2	MOTOR INSTALLATION GUIDELINE	28
3.1.3	BEARING LOAD CAPACITY	29
3.1.4	COUPLING	32
3.1.5	RUNOUT	33
3.2	TECHNICAL MOTOR DATA	34
3.2.1	STANDARDS FOR MOOG MOTORS	34
3.2.2	MOTOR PERFORMANCE DATA	37
3.2.3	TORQUE SPEED CHARACTERISTIC G400 SERIES MOTORS	39
3.2.4	TORQUE-SPEED-CHARACTERISTICS G300 SERIES MOTORS	43
3.2.5	MOTOR BRAKE DATA	45

<b>4</b>	<b>INSTALLATION</b>	<b>47</b>
<b>4.1</b>	<b>WIRING</b>	<b>47</b>
<b>4.2</b>	<b>CONNECTOR OVERVIEW</b>	<b>48</b>
4.2.1	MOTOR AND POWER CONNECTOR TB1	49
4.2.1.1	TB1 POWER CONNECTOR PINOUT	52
4.2.1.2	ACCESSORY POWER PART	52
4.2.2	RESOLVER CONNECTOR J1	54
4.2.2.1	ACCESSORY RESOLVER PARTS	55
4.2.3	SERIAL PORT CONNECTOR J2	56
4.2.4	AXIS SIGNALS CONNECTOR J3	57
4.2.5	ENCODER SIMULATION CONNECTOR J4	60
4.2.6	LOGIC POWER CONNECTOR J5	62
<b>5</b>	<b>L180 GRAPHICAL USER INTERFACE</b>	<b>63</b>
<b>5.1</b>	<b>SYSTEM REQUIREMENTS</b>	<b>63</b>
<b>5.2</b>	<b>GUI INSTALLATION</b>	<b>63</b>
<b>5.3</b>	<b>SYSTEM INFORMATION</b>	<b>64</b>
<b>5.4</b>	<b>USING THE L180GUI</b>	<b>64</b>
5.4.1	TOOLBAR	65
5.4.2	QUICK START	66

<b>5.4.3</b>	<b>GENERAL INSTRUCTIONS</b>	<b>67</b>
<b>5.4.4</b>	<b>SERIAL LINK</b>	<b>69</b>
<b>5.4.5</b>	<b>PARAMETER FILE DOWNLOAD</b>	<b>69</b>
<b>5.4.6</b>	<b>PARAMETER SETTING</b>	<b>70</b>
5.4.6.1	ADJUST OPTIONS	71
5.4.6.2	ENCODER SIMULATION CONFIGURATION	74
5.4.6.3	SPEED LOOP TUNING	76
5.4.6.4	CURRENT LOOP TUNING	81
5.4.6.5	MOTOR PARAMETERS	83
<b>5.4.7</b>	<b>AUTOMATIC COMMAND MODE (FUNCTION GENERATOR)</b>	<b>86</b>
<b>5.4.8</b>	<b>UPLOAD OF PARAMETER FILES</b>	<b>88</b>
<b>5.4.9</b>	<b>SCOPE</b>	<b>89</b>
<b>5.4.10</b>	<b>FIRMWARE UPGRADE</b>	<b>90</b>
<b>5.4.11</b>	<b>EDIT PARAMETER FILE</b>	<b>91</b>
<b>5.4.12</b>	<b>PRIVILEGED ACCESS</b>	<b>92</b>
<b>5.4.13</b>	<b>SOFTWARE DRIVE RESET</b>	<b>92</b>
<b>5.4.14</b>	<b>SOFTWARE PREFERENCES</b>	<b>92</b>
<b>5.4.15</b>	<b>DRIVE AND MOTOR INDICATIONS</b>	<b>93</b>

<b>6</b>	<b>SYSTEM DESCRIPTION</b>	<b>95</b>
6.1	SERVO STOP	95
6.2	DISPLAY INDICATION	96
6.2.1	REGULAR INDICATION	96
6.2.2	WARNING INDICATION	96
6.2.3	ALARM INDICATION	97
6.2.4	ALARM HANDLING	97
6.3	TROUBLE SHOOTING GUIDE	98
6.3.1	DRIVE RESET	101
6.3.2	OTHER PROBLEM SOURCES	102
6.4	FAILURE REPORT	103



**TABLE OF FIGURES**

Figure 1: Maximum Regeneration Capability ..... 19

Figure 2: Dimensions front and side ..... 20

Figure 3: Installation and drill plan ..... 20

Figure 4: Drive Overview ..... 21

Figure 5: Drive Nameplate ..... 22

Figure 6: Motor Nameplate (values merely as example) ..... 27

Figure 7: Radial Load Capacity Gxx2 ..... 29

Figure 8: Radial Load Capacity Gxx3 ..... 30

Figure 9: Radial Load Capacity Gxx4 ..... 30

Figure 10: Radial Load Capacity G4x5 ..... 31

Figure 11: Motor Load Coupling ..... 32

Figure 12: Runout ..... 33

Figure 13: Concentricity Figure 14: Perpendicularity ..... 33

Figure 15: Torque-Speed Char. G2L05 Figure 16: Torque-Speed Char. G2L10 ..... 39

Figure 17: Torque-Speed Char. G2L20 Figure 18: Torque-Speed Char. G2L40 ..... 39

Figure 19: Torque-Speed Char. G3L05 Figure 20: Torque-Speed Char. G3L15 ..... 40

Figure 21: Torque-Speed Char. G3L25 Figure 22: Torque-Speed Char. G3L40 ..... 40

Figure 23: Torque-Speed Char. G4L05 Figure 24: Torque-Speed Char. G4L10 ..... 41

Figure 25: Torque-Speed Char. G4L20 Figure 26: Torque-Speed Char. G4L40 ..... 41

Figure 27: Torque-Speed Char. G4L60 ..... 41

Figure 28: Torque-Speed Char. G5L10 Figure 29: Torque-Speed Char. G5L20 ..... 42

Figure 30: Torque-Speed Char. G5L30 Figure 31: Torque-Speed Char. G5L50 ..... 42

Figure 32: Torque-Speed Char. L2L10 Figure 33: Torque-Speed Char. L2L20 ..... 43

Figure 34: Torque-Speed Char. L3L15 Figure 35: Torque-Speed Char. L3L25 ..... 43

Figure 36: Torque-Speed Char. L4L10 Figure 37: Torque-Speed Char. L4L20 ..... 44

Figure 38: Current/time and torque/time diagrams ..... 45

Figure 39: Wiring Overview ..... 48

Figure 40: TB1 Wiring ..... 50

Figure 41: Multi Axis Wiring ..... 51

Figure 42: Resolver wiring, DSUB 9 male cable to J1 ..... 54

Figure 43: Serial link wiring, DSUB9 female cable to J2 and PC ..... 56

Figure 44: J3 Axis Signals Wiring, DSUB25 male cable to J3 ..... 57

Figure 45: Encoder Output, DSUB15 male cable to J4 ..... 60

Figure 46: Definition of Encoder Signals, viewed from the shaft side ..... 60

Figure 47: J5 Logic Power Wiring, DSUB15 female cable to J5 ..... 62

Figure 48: Main Window ..... 64

Figure 49: Parameters Setting ..... 66

Figure 50: Warning for ENTER parameters Figure 51: Warning for SAVE parameters ..... 67

Figure 52: GUI dialog box features ..... 68

Figure 53: Setting Serial Port ..... 69

Figure 54: Parameter Download ..... 70

Figure 55: Setting Adjust Options ..... 71

Figure 56: Command Slope ..... 73

Figure 57: Encoder Simulation Configuration ..... 74

Figure 58: Encoder Signals ..... 76

Figure 59: Adjust Speed Loop Parameters ..... 76

### TABLE OF FIGURES

Figure 60: Speed Loop Regulator .....	77	
Figure 61: Speed Step, proportional gain .....	80	
Figure 62: Speed Step, integral gain.....	80	
Figure 63: Adjust Current Loop Parameters.....	81	
Figure 64: Current Loop Regulator.....	82	
Figure 65: Motor Parameters .....	84	
Figure 66: Warning during automatic command mode start-up .....	86	
Figure 67: Automatic command mode.....	86	
Figure 68: Warning after quit of the automatic command mode.....	87	
Figure 69: Warning analog command applied.....	87	
Figure 70: Parameter Upload .....	88	
Figure 71: Notes of parameter files .....	88	
Figure 72: Scope.....	89	
Figure 73: Firmware Upgrade .....	90	
Figure 74: Parameter File Editor .....	91	
Figure 75: Preferences .....	92	
Figure 76: Drive GUI Indications.....	93	
Figure 1: End switch Configuration for servo stop, connector J3 .....	95	
Figure 2: Definition of sense of rotation, viewed from the shaft .....	96	
Figure 79: A1 firmware operation power module	Figure 80: A1 firmware Monitoring relay .....	98
Figure 81: A2 firmware Monitoring relay	Figure 82: A2 firmware operation power module .....	99

## **1 DESCRIPTION AND TECHNICAL DATA**

---

### **1.1 INTRODUCTION**

---

The L180 servo drive is intended to control MOOG brushless servo motors. These are 3 phase motors with 8 or 12 poles (4 or 6 polepairs) equipped with a two pole resolver.

The L180 servo drive is fully digital. High-performance torque and speed control fulfill all requirements for fast response and high control accuracy.

Digital control allows comprehensive diagnostics, motor parameters tuning, data and fault detection, etc... using a PC based Graphical User Interface (GUI).

### 1.1.1 DESCRIPTION

---

The features of the L180 servo drive are described below:

#### Power supply

- Single axis unit incorporating regeneration module minimizing wiring and space requirements.
- 230V three phase or single phase.
- Option: External filters in power source for CE compliance.
- Drive designed according protective extra low voltage standards (PELV). An autotransformer is sufficient for the main power input.

#### Power driver

- Galvanic isolation between control and power electronics.
- IGBT output stage.
- Digital PWM current loop providing low ripple motor currents and high motor efficiency.

#### Digital controller

- Full-digital servo drive for brushless motor with resolver.
- Easy software download through RS232 serial link.
- Temperature regulated fan-cooling.
- Multi loop control (torque and speed).
- Sinusoidal current output ensures smooth torque and performance at low speed.
- 7 segment status indicator for diagnostic display.

#### User's inputs

- $\pm 10$ VDC differential analog input for speed or current command.
- RS232 serial port.
- Limit switches for overrun protection in both directions.
- Optional external 24VDC power supply to the control and interface boards in case of main power supply interruption.

#### User's outputs

- Programmable incremental encoder output simulation with resolution from 1 to 2048 ppr (extrapolation), differential RS 422 line driver outputs.
- Programmable monitoring relay to indicate ready, alarm or enable status.

#### Protections

- Power stage protected against short-circuit and over-temperature.
- Motor thermal protection by I<sup>2</sup>t limitation and thermistor.
- Detection of resolver fault, motor wiring failure.

## 1.2 INSTRUCTIONS TO THE MANUAL

---



### CE-COMPLIANCE

The symbol on the left indicates where a particular application-related safety or EMC requirement is driven by the need for CE-Compliance of the L180 when installed in the system. Customers who do not need CE-Compliance on their machinery may choose not to implement these features.



### DANGER

#### HIGH VOLTAGE

The symbol on the left indicates high voltages which can be extremely dangerous or lethal if touched and **may result in personal injury**.

These instructions must be followed.



### WARNING

The symbol on the left is used to draw attention to safety instructions concerning potential **damage to the servo drive and motor**.

These instructions must be followed.

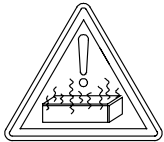

### BEWARE OF HOT PARTS

The symbol on the left indicates hot parts which can be dangerous if touched and **may result in personal injury**. These parts must be protected to prevent contact.

These instructions must be followed.

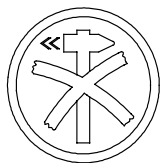

### DELICATE PART

The symbol on the left is used to draw attention to installation instructions concerning potential **damage to the servo drive and motor**. These parts must be handled with care.

These instructions must be followed.

This user's manual is written with the intention to supply all necessary information for servo drive applications. In any case of uncertainty of the drive reaction or missing information, please do not hesitate to contact your local MOOG application engineer.

### 1.3 TECHNICAL DATA

#### 1.3.1 DESIGN STANDARDS

The low voltage circuits of the L180 drive are designed as protective extra low voltage circuits (PELV) thus an autotransformer can be used for the main line voltage.

*Table 1: Drive Design Standards*

Code	Year	Description
89/366/EEC; 98/13/EEC	1998	EMC Directive
IEC 61800-3	1996-06	adjustable speed electrical power drive systems EMC product standard
EN 50082-2	1995-03	generic immunity standard
IEC 61000-4-2	1995	electrostatic discharge immunity test
IEC 61000-4-3	1995	radiated radio-frequency electromagnetic field immunity test
IEC 61000-4-4	1995	electrical fast transient, burst immunity test
IEC 61000-4-5	1995	surge immunity test
IEC 61000-4-6	1995	immunity to conducted disturbances, induced by radio-frequency fields
EN 50081-2	1993-08	generic emission requirements
EN 50081-2		Group 1, Class A, conductive emission requirements (0.15 to 30 MHz)
EN 50081-2		Group 1, Class B, radiated emission requirements (30 to 1000 MHz)
EN 50178	1997-10	electronic equipment for use in power installations
73/23/EEC; 93/68/EEC	1993-02	low voltage directive

#### 1.3.2 MODEL NUMBER SELECTION

The L180 family uses a 12 character coding system to identify the unique attributes of each model. The coding system is shown Table 2.

Table 2: Model Number Selection

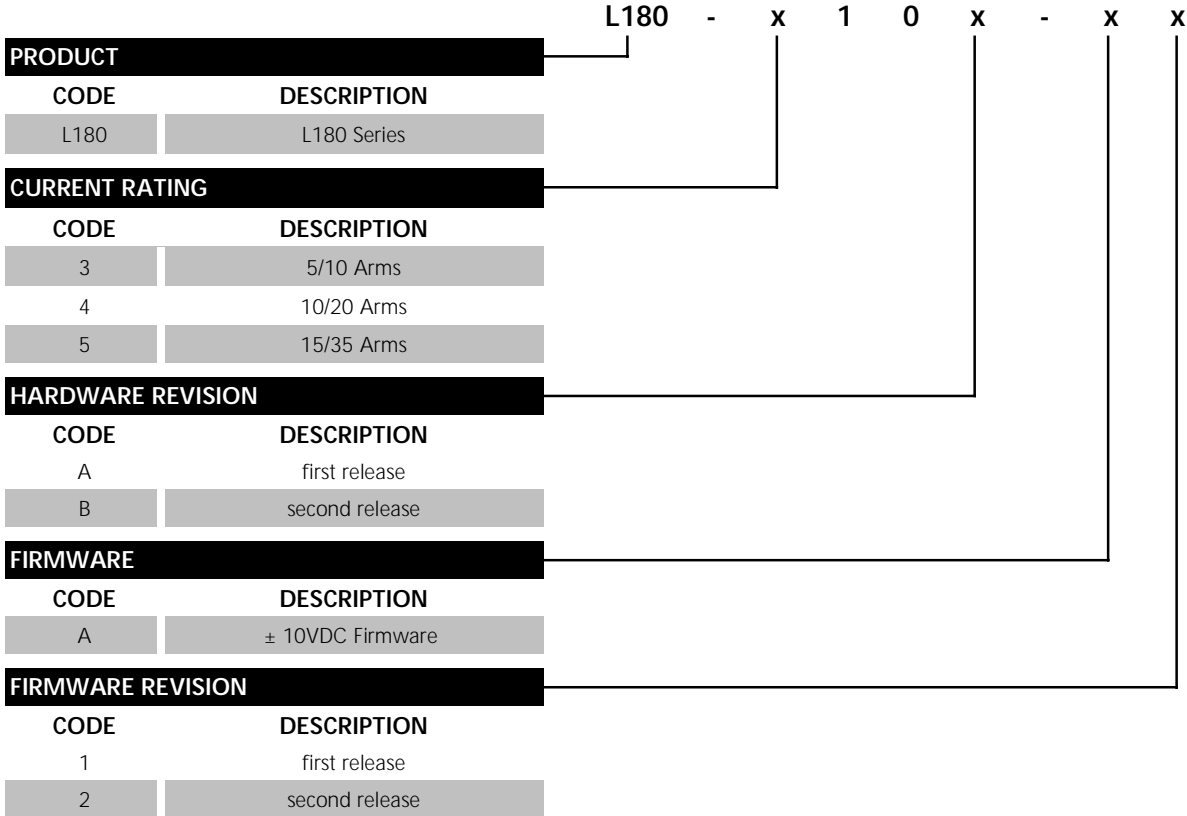

Possible drive model numbers are L180-310A-A1, L180-410A-A1, L180-510A-A1, L180-310A-A2, L180-410A-A2, L180-510A-A2, L180-310B-A2, L180-410B-A2 or L180-510B-A2.

### 1.3.3 ACCESSORIES

Table 3: Accessories

Part	Part Number	Length	Motor	Description
L180 Manual	C08476-001	-	-	L180 User's Manual, english version
L180GUI Installation Disk	C08478-001 C08478-002	obsolete	-	L180 Windows based Graphical User Interface (L180GUI), Motor parameter files
Visual Indication Sticker	C08499-001	-	-	Sticker which explains in short terms the 7 segment display indication. Supplied with each drive, spare part.
Raw Power Cable note ❶	B47890-001	available in customary lengths	Gxx2, Gxx3, Gxx4	Shielded cable for customer configuration
Raw Power Cable note ❶	B47903-001	available in customary lengths	G4x5	Shielded cable for customer configuration
Motor Power Connector	A63472-001	-	Gxx2, Gxx3, Gxx4	Power connector for customer configuration, smallest version
Motor Power Connector	C08365-001	-	Gxx2, Gxx3, Gxx4	Power connector for customer configuration, easier to assemble
Motor Power Connector	B47736-001	-	G4x5	Power connector for customer configuration
Motor Power Cable	C08336-001-010 C08336-001-020	10m 20m	Gxx2, Gxx3, Gxx4	Prefabricated motor cable with mating motor connector and ferrule ended leads
Motor Power Cable	B47915-001-010 B47915-001-020	10m 20m	G4x5	Prefabricated motor cable with mating motor connector and ferrule ended leads
Serial Port RS232 cable	C08475-001	5m	-	Commisioning cable between PC and drive
Signal Cable	C08335-003-010 C08335-003-020	10m 20m	all motors	Prefabricated signal cable with mating connector
Drive mating power conn	C08474-001	-	-	Mating power connector for all drives. Supplied with each drive, spare part.
Raw signal cable note ❶	B47885-001	available in customary lengths	all motors	Shielded cable for customer configuration
Motor mating signal conr	C08485-001	-	all motors	Signal connector for customer configuration
L180 connector kit 1	C53106-001	-	-	Solder cup kit for use with 10 in clearance cabinet, contains J1, J3, J4, J5 mating connector
L180 connector kit 2	C53107-001	-	-	Solder cup kit for use with 12 in clearance cabinet, contains J1, J3, J4, J5 mating connector
L180 connector kit 3	C53108-001	-	-	Screw terminal kit for use with 12 in clearance cabinet, contains J1, J3, J4, J5 mating connector

note ❶: consult local sales office



#### 1.3.4 GENERAL DATA

Table 4: General Data

Description	Unit	L180
Backup Voltage	VDC	24 (20 -28)
Supply Voltage line to line, three and single phase	VAC	230 +10% -20%
Supply frequency	Hz	45 to 65
Operating temperature range	° C	0 to 60
Operating temperature range at full power (from 50°C, reduce output current by 2%/°C to 60°C)	° C	0 to 50
Storage temperature range	°C	-20 to +70
PWM chopper frequency	kHz	7,5
Differential input reference	V	+ 10 to -10
Continuous regeneration power	W	300
Output frequency to motor	Hz	0 to 500
Incremental encoder simulation	ppr	1 to 1024 (2048)
Theoretical max. speed for motor with resolver "speed one"	rpm	7500
ON-Switching threshold of regeneration resistor	VDC	385
OFF-Switching threshold of regeneration resistor	VDC	380
ON-Trip threshold of DC-BUS overvoltage	VDC	410
OFF-Trip threshold of DC-BUS overvoltage	VDC	400
OFF-Trip threshold of DC-BUS undervoltage	VDC	230
ON-Trip threshold of DC-BUS undervoltage	VDC	220
Baud rate, fixed	Bd.	9600
Transmission		Full duplex
Serial Link Format		1 START bit, 8 DATA bit, no parity, 1 STOP bit
International Protection		IP20
Indicative weight	kg	3.2
Dimensions (Width,Depth,Height)	mm	76.5, 200, 295

Units in VAC are root mean square (rms) values.

### 1.3.5 ELECTRICAL DATA

#### 1.3.5.1 DRIVE RATINGS

Table 5: Drive Power Ratings

3~ main line	Unit	L180-310A	L180-410A	L180-510A
continuous current	Arms	5	10	15
	Apeak	7	14	21
maximum current	Arms	10	20	36
	Apeak	14	28	50
continuous power	kW	2	4	6
maximum power	kW	4	8	14

Single phase operation causes a power reduction to 1/3 of the power rating above

#### Conversion formula:

$$I_{rms} = \frac{I_{peak}}{\sqrt{2}}$$

$$U_{rms} = 230V_{rms}$$

$$P = \sqrt{3} \cdot I_{rms} \cdot U_{rms}$$

#### 1.3.5.2 POWER DISSIPATION

The power dissipation can be computed with the following formula:

$$P_{disp} [W] = 9 \cdot I_{rms} + 20 + P_{brake}$$

$P_{disp}$ : total power dissipation in Watt

9: calculation constant in Watt per Arms

$I_{rms}$ : continuous current to the motor in Arms

20: power dissipation under no load conditions in Watt

$P_{brake}$ : actual regeneration power of the resistor in Watt

**1.3.5.3 REGENERATION POWER**

*Table 6: Regeneration Power Rating*

Regeneration power	Unit	for all L180 drives
regeneration Resistor	$\Omega$	39
maximum regeneration power	W	3800
continuous regeneration power	W	300
maximum ON-time at max. regen power	ms	60
minimum period at max. ON-time	s	1

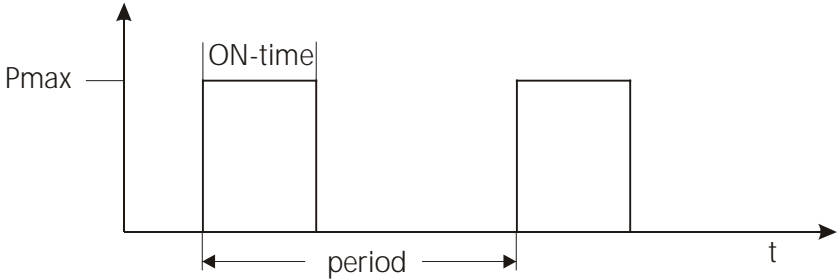

*Figure 1: Maximum Regeneration Capability*



**WARNING**

The maximum and continuous regeneration power of the drive is limited. An external regeneration resistor or DC-BUS terminal is not available. The regeneration power requirements of the application must meet with the drive capabilities.

If the application regeneration power is above the maximum drive regeneration power an overvoltage alarm will occur immediately. If the application regeneration power is above the continuous drive regeneration power an overheating alarm will occur after a certain period of time. This time depends on the continuous regeneration power.

For calculation of regeneration power for your specific application please get in contact with your local MOOG application engineer.

#### 1.3.6 MECHANICAL DIMENSIONS

Dimensions are in millimeter (and inches in brackets)!

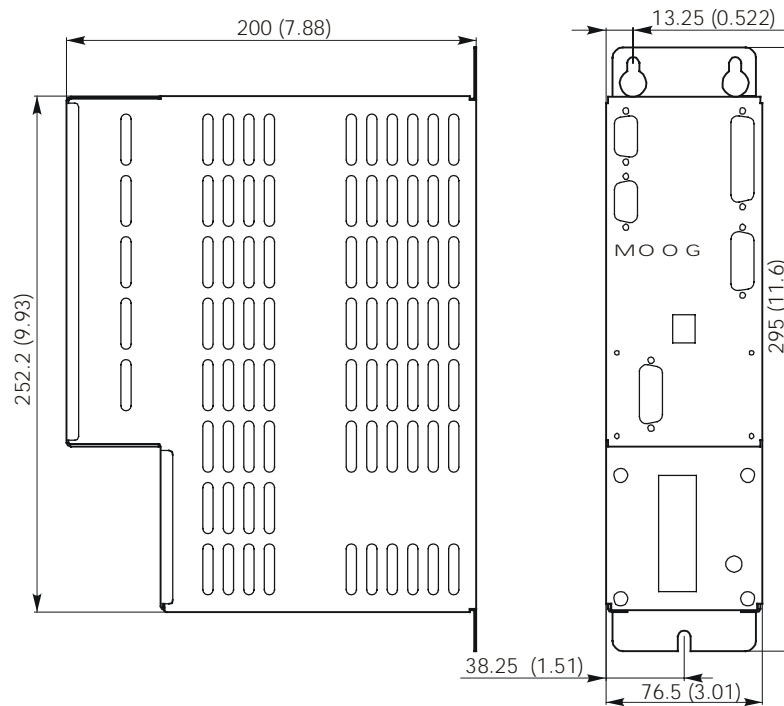

Figure 2: Dimensions front and side

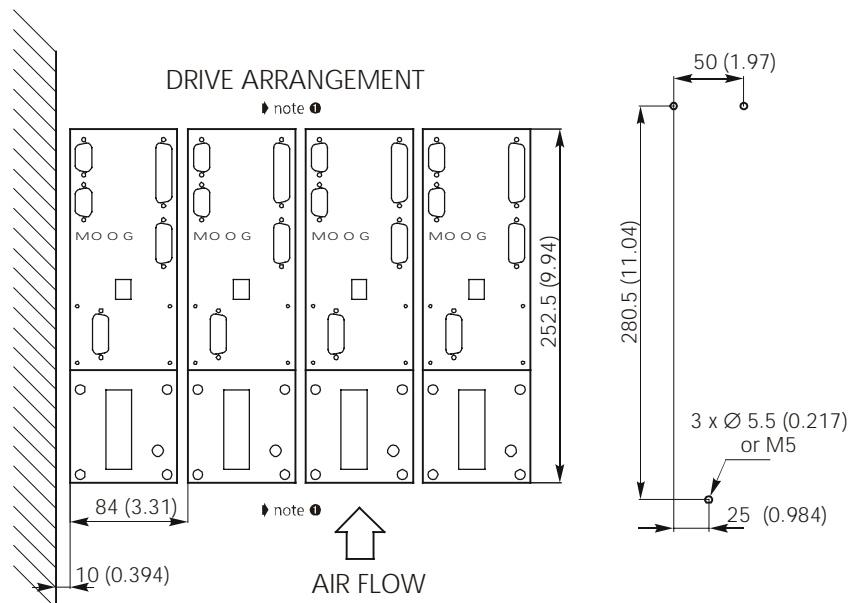

Figure 3: Installation and drill plan

note ❶: 100 mm (3.94 in) top and bottom clearance required!

1.3.7 DRIVE OVERVIEW

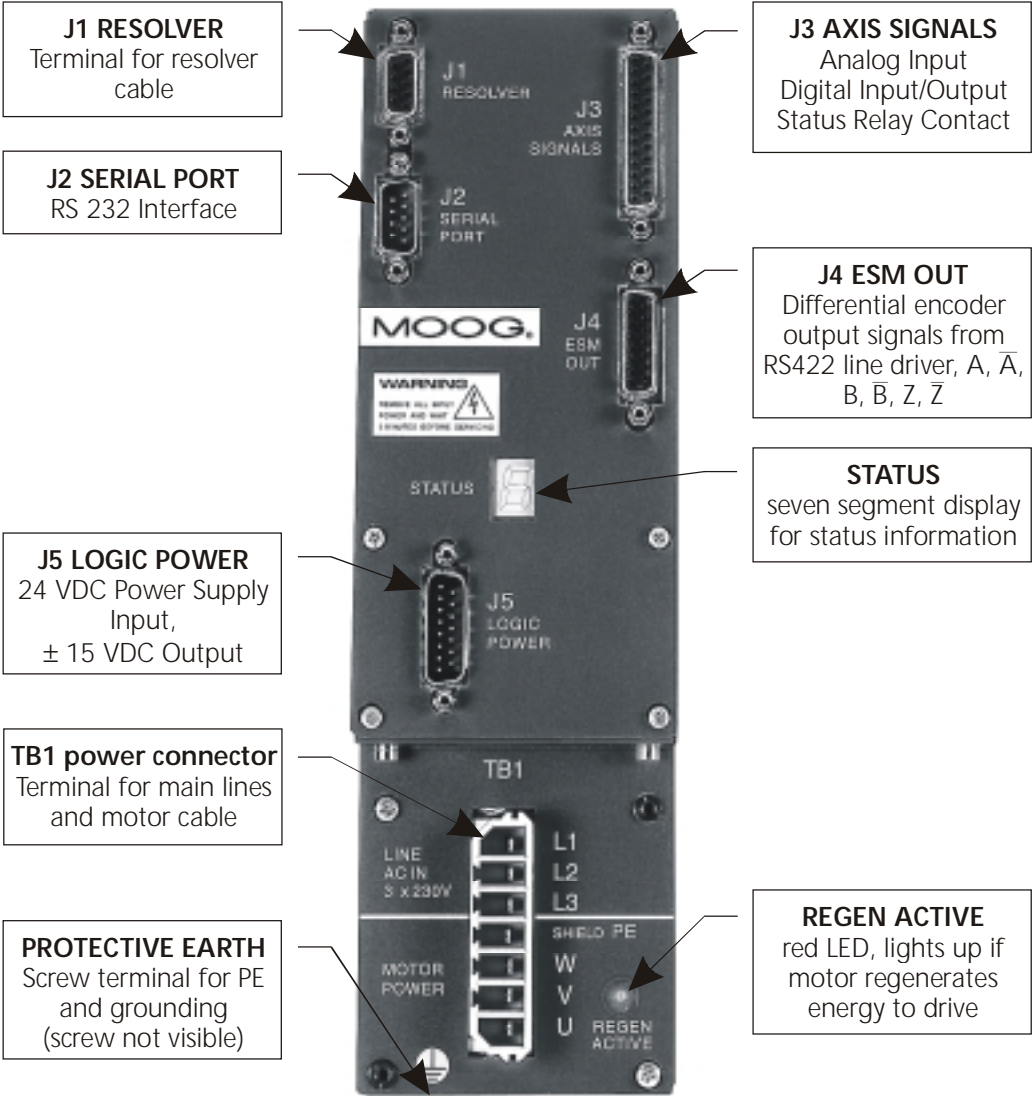

Figure 4: Drive Overview

### 1.3.8 DRIVE NAMEPLATE

Please compare received servo drive model listed on nameplate against ordered model. When contacting MOOG please provide nameplate information.

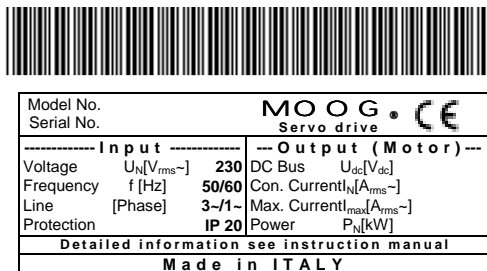

Figure 5: Drive Nameplate

The barcode above the nameplate in 3 of 9 style (also called barcode 39) contains the model and the serial number segregated by a space bar character.

#### Performance Data

Con. Current	continuous output current to motor
Max. Current	maximum output current to motor
Power	nominal continuous power to motor

#### General Data

Voltage	Line phase to phase voltage
Frequency	line frequency
Line	Line number of phases
Serial No.	Serial number
Model No.	Model number, see table 2
DC BUS	internal DC BUS voltage

#### Standards

Protection	Degree of international protection
CE	Conformity certificate will be supplied on request

## 2 SAFETY INSTRUCTIONS

---

### 2.1 QUALIFIED PERSONNEL

---



#### **WARNING**

The components making up the drive system may only be installed and serviced by qualified personnel. The local regulations for accident prevention, electronic devices, electric installations and machinery must be observed.

Unqualified work on the drive components and failure to comply with the warnings contained in this manual or affixed to the components can be lethal or cause damage to property.

The work permitted within the scope of this manual may consequently only be undertaken by qualified personnel.

This includes the following people:

- **planning and engineering design personnel** familiar with the safety guidelines for measurement, electronic devices, machinery equipment, electric installations and control instrumentation,
- **operating personnel** who have been instructed with regard to the handling of electronic devices, machinery equipment, servo drives and who are familiar with the operating instructions contained in this manual,
- **commissioning and service personnel** authorized to start up, ground and mark these systems in accordance with safety engineering standards. These persons must be qualified service personnel according to the local regulations.

The design standards offer additional information about the safety of the L180 servo drive.

### 2.2 MAIN SAFETY INSTRUCTIONS

---



#### **DANGER**

#### **HIGH VOLTAGE**

The servo drives operate with potentially lethal voltages.

For this reason:

- **Disconnect the system from the mains supply.**  
Before starting any work on the drive system, it must be disconnected from the main voltage and secured against inadvertent reconnection by means of the disconnect switch. Do not remove the plugs for the motor and mains supply while the L180 servo drive is connected to mains power.
- **The servomotor must come to a complete stop.**  
Rotating servomotor can generate potentially lethal voltages by acting as generator.
- It is **NOT** sufficient to simply disable the drive.



#### **DANGER**

#### **HIGH VOLTAGE**

The capacitors in the servo drive may still be charged.

For this reason:

- **Note the discharge time of the capacitors.**  
The servo drive contains capacitors which may be charged up to 410 VDC. Wait at least 5 minutes for the capacitors to discharge after disconnecting the main voltage.



#### **WARNING**

The servo drive is designed for use in cabinets and has an IP 20 rating. A cabinet is recommended which has an IP rating of at least IP54.



**WARNING****BEWARE OF MECHANICAL HAZARDS!**

Servomotors can accelerate highly dynamically. They also have enormous torque. The following points must therefore be observed when starting the system.

- **The danger zone of the motor must be cordoned off.**  
The system must feature a safety guard to prevent personnel from reaching into or entering the danger zone. If the safety system is tripped, the drive system must be disconnected from the main voltage immediately.
- **Motor may accelerate inadvertently**  
The motor may accelerate inadvertently due to wiring faults or errors in the application software. Appropriate safety precautions must be taken to ensure that neither personnel nor machine components are endangered in any way.
- **Coast stop**  
Any failure of the servo drive leads to a coast stop of the motor.

**2.3 INFORMATION ON EMC**

---

**CE-COMPLIANCE**

The information on EMC provided here contains general recommendations to assist the machine manufacturer when installing L180 components made by MOOG in finished products which must conform to the requirements of EC Directive 89/336/EEC (EMC Directive). Although MOOG has exercised utmost care in compiling these recommendations, we cannot accept any liability whatsoever for claims associated with the user's individual applications. This also applies with regard to non-performance, non-compliance, faults, misunderstandings and mistaken interpretation.

Responsibility for ensuring that every finished product containing these components conforms to the requirements of the EMC Directive rests entirely with the machine manufacturer of the finished product. MOOG cannot accept any liability whatsoever for finished products made by other manufacturers and containing L180 components from MOOG.

### EMC environment

The L180 components from MOOG are designed for installation in industrial equipment and for operation in industrial areas. The L180 components from MOOG have therefore been tested in accordance with the EMC standards, mentioned in the design standards.

### Installation of the components

All ground connections between the servo drive cover and the control cabinet must be securely mounted to guarantee a continuous ground connection. The L180 servo drive is designed for emission minimization to ensure secure connection between the drive and the baseplate in conjunction with EMC requirements. The drive has to be connected with protective earth on the earth stud to ensure proper grounding.

To ensure an optimum EMC shield, the control cabinet should have a continuous ground connection between all metal panels (frame, side panels, top, baseplate, etc.). A control cabinet which has been designed to provide an optimum EMC shield can be used for this purpose.

The machine manufacturer must design the system to prevent interference between subsystems, modules, power supplies, and/or any other component. Furthermore, the complete system must be designed such that there is no interaction between actual and potential sources of interference. The machine manufacturer is responsible for taking suitable precautions to minimize such interference. For example, safe distances must be maintained between potentially interfering components in addition to the use of proper shielding. The machine manufacturer is responsible for the design methods used to integrate all system components together in order to prevent any interference. The machine manufacturer must decide which is the most efficient method for the complete product.

Where possible, shielded cables with fully shielded connector housings should always be used. The cable shield must be connected to the connector shields over the full 360° circumference in order to ensure a continuous all-round ground connection. All cable connections to the servo drive must be tightly secured. In particular, all screws in the ground connections of the connector shields must be securely tightened. To avoid potential interference, power and signal cables must be routed as far apart as possible in the control cabinet and on the entire finished product. If power and signal cables must be crossed, the cables should be crossed perpendicular to each other to minimize interference. The machine manufacturer of the complete product must decide which is the most efficient method.

Further details on filtering, grounding and shielding can be found in this manual.

### 3 SERVOMOTORS

A Moog L180 servo drive system consists of a L180 and a Global series servomotor. The Global series motor nameplate (see Figure 6) lists both the motor model and the motor's electrical type. The motor electrical type can be used to configure the L180 with the appropriate motor parameters.

### 3.1 MOUNTING AND INSTALLATION

#### 3.1.1 MOTOR NAMEPLATE

Please compare received servo motor model listed on nameplate against ordered model. When contacting MOOG please provide nameplate information.

⊕ AC-Servo	S/N: N131	Date: 4Q96	⊕
Model: G422-414	Typ: G2L10, brake 0,9 Nm		
IP65 I.CI.F-100K IEC34 NEMA-MG7 VDE-0530-S1			
<b>MOOG</b>		<i>G400 Series</i>	
MOOG GmbH D-71034 Böblingen		Brushless Servomotor	
$n_N$ : 7400	$\text{min}^{-1}$	$n_{max}$ : 10000	$\text{min}^{-1}$
$J$ : 0,15	$\text{kgcm}^2$	$M_0$ : 0,5	Nm
⊕ Data at 25°C		$R_{tt}$ : 20,7	Ohm
		$U_d$ : 325	V ⊕
		$P_N$ : 0,325	kW
		$I_0$ : 1,2	$A_{rms}$

Figure 6: Motor Nameplate (values merely as example)

#### General Data

S/N:	serial number
Date:	production quarter and year
Model:	motor model number
Type:	electric model, description optional brake
J:	rotor inertia
Rtt:	terminal to terminal resistance
Ud:	bus voltage

#### Performance Data

$n_N$ :	nominal speed (speed at $P_N$ )
$n_{max}$ :	maximum speed
$P_N$ :	nominal power (maximum continuous power)
$M_0$ :	continuous stall torque
$I_0$ :	continuous stall current

Additional motor data can be found in the motor catalog. Devices without nameplate are not covered by the manufacturer's warranty and must not be put into operation.

#### 3.1.2 MOTOR INSTALLATION GUIDELINE

---

MOOG recommends that hexagon socket head screws to DIN 912 8.8 be used to secure the motor. Assembly is made very much easier by using an Allen key with ball head, particularly in the cases of motor sizes 2 and 3. The screws used to install these motor sizes must not be more than 40 mm long.

MOOG motors can become very hot (up to 155°C winding temperature) in operation. Good heat dissipation must therefore be ensured when installing the motor, i.e. it should be flanged onto a suitably solid metal part of the machine. Adequate convection must also be ensured. In individual cases, the motor must furthermore be protected against contact due to the risk of burns. Forced cooling (e.g. with fans) will increase the continuous power, while bad convection may decrease the continuous performance.

Before connecting a coupling to the motor shaft, the shaft must be thoroughly degreased. When using a degreasing agent, care must be taken to prevent it entering the bearing. Otherwise the bearings permanent lubrication can no longer be guaranteed. MOOG recommends the use of a clamp coupling or shrink connection to ensure reliable torque transmission. An inexpensive and service friendly connection is possible with the slot and key option (ensure tight slot tolerances).

Impermissibly high axial and radial forces on the shaft can result in motor damage during installation. The service life of the motor is impaired if the bearing is damaged in any way. Adjusting the rotor shaft by force can impair the correct functioning of the optional brake to such an extent that it has little or no braking effect. Excessive pressure and impacts on the front end of the shaft and rear housing cover must therefore be avoided under all circumstances.

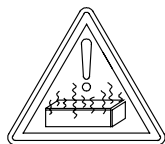

#### **BEWARE OF HOT PARTS** (sticker on servo motor)

In extreme applications, the surface of the servomotor may heat up to more than 100 °C and can cause skin burns if touched. The servomotor must therefore be protected to prevent contact.

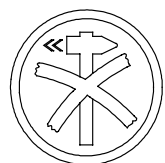

#### **DELICATE PART** (sticker on servo motor)

A hammer must not be used to force the gearing or gearwheel onto the shaft when installing such parts. The screw thread in the center of the shaft must be used for this purpose. An extractor supported on the center of the shaft must be used when dismantling the parts. The permissible axial and radial forces are in all cases exceeded by the impulses due to hammering.

#### 3.1.3 BEARING LOAD CAPACITY

Radial load capacity, shown in Figure 7 to Figure 10, are for a B10 life of 20,000 hours. The load is applied at shaft extension midpoint. Curves are based on minor axial shaft loads. Consult factory for other loading conditions. Maximum permissible axial and radial forces for brushless MOOG servomotors during installation refer to Table 7.

Table 7: Installation Loads

Motor size	Gxx2	Gxx3	Gxx4	G4x5
Axial force note ❶	150N	150N	300N	400N
Radial force note ❶	500N	500N	1000N	1600N

note ❶: During installation. Lower loads apply for the rotating motor, see catalog.

Motor Series Gxx2

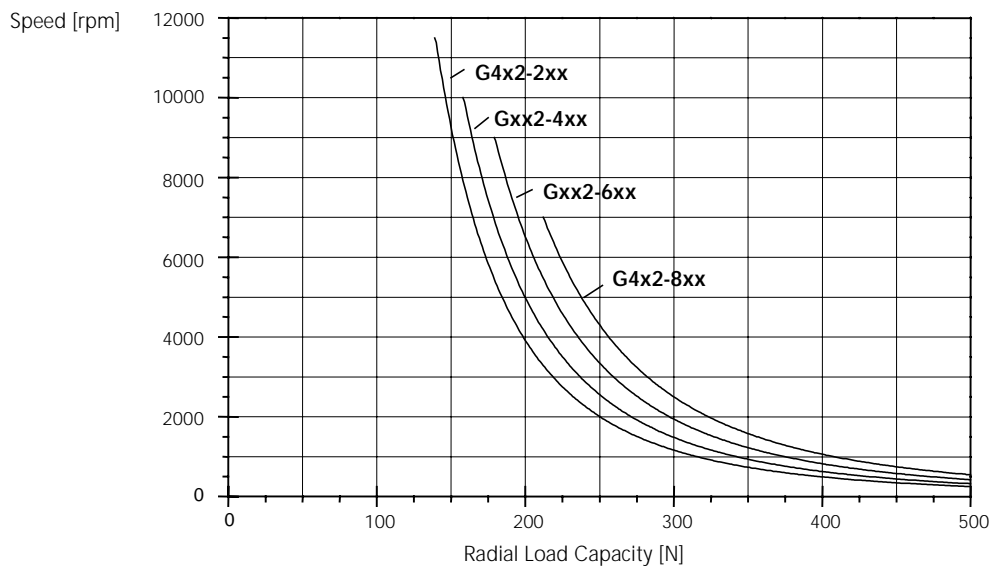

Figure 7: Radial Load Capacity Gxx2

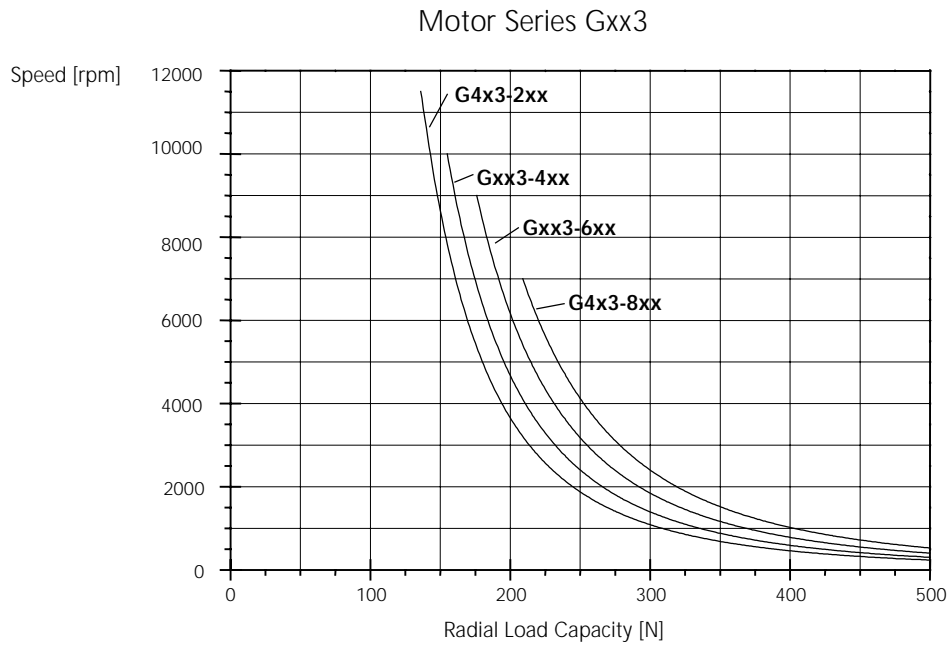

Figure 8: Radial Load Capacity Gxx3

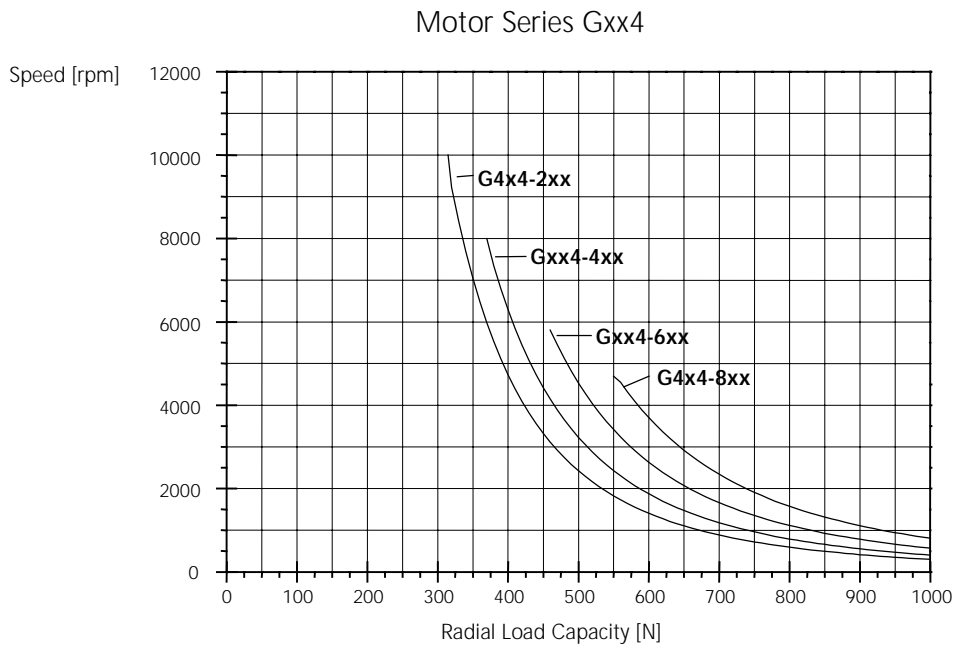

Figure 9: Radial Load Capacity Gxx4

Motor Series G4x5

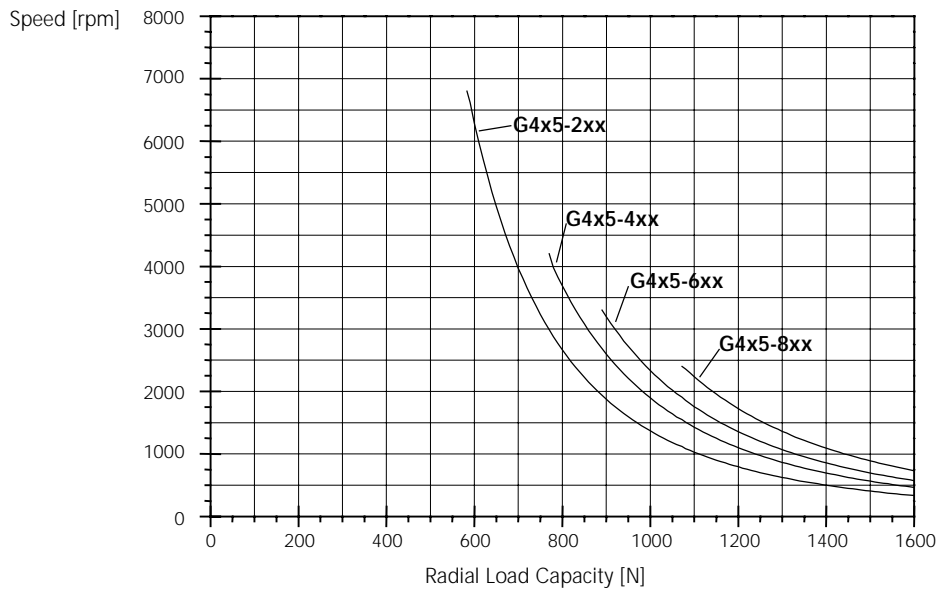

Figure 10: Radial Load Capacity G4x5

#### 3.1.4 COUPLING

A flexible coupling offers the advantages of economy, allowance for misalignment, and reduction of backlash. Flexible disc or bellows style couplings are recommended. The couplings are available for both plain shaft as well as for slot and key configurations. The shaft key should then be a close clearance or light press fit into the coupling key-way. Refer to Figure 11, for flexible coupling detail.



#### WARNING

A rigid coupling should not be used. Normal runouts and eccentricities will result in damage to motor and/or load shaft and bearings.

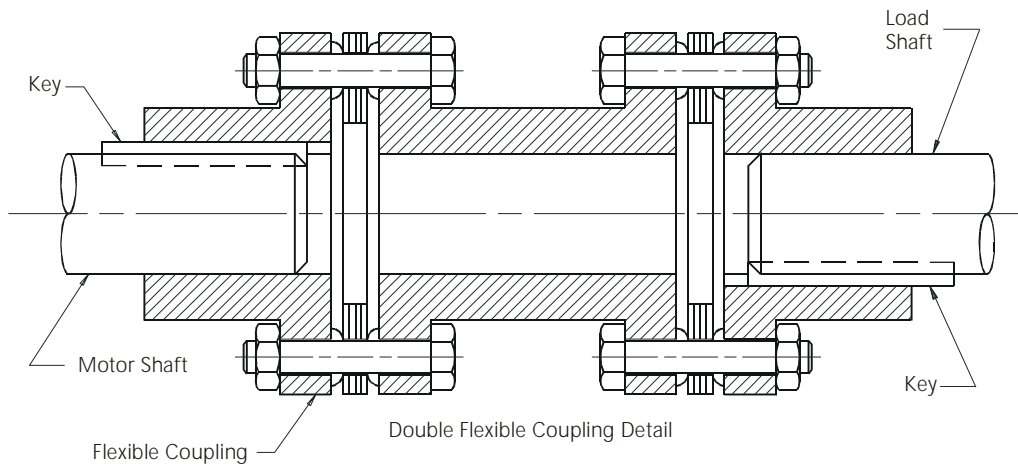

Figure 11: Motor Load Coupling



### 3.1.5 RUNOUT

The reduced runout provided by MOOG motors allows the attachment of various gear heads. The precision manufacturing of the motor avoids loads caused by misalignments between motor and gear heads.

Table 8: Shaft Runout

Diameter of the Shaft Extension $\phi U$ [mm]	Maximum Runout Tolerance	
	Class R [mm]	Class N [mm]
to 10	0.015	0.030
over 10 to 18	0.018	0.035
over 18 to 30	0.021	0.040
over 30 to 50	0.025	0.050

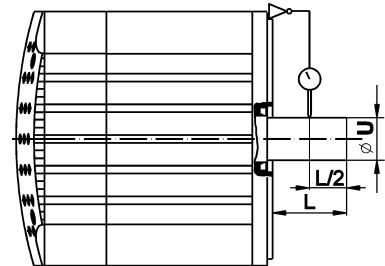

Rundlauf / runout

Figure 12: Runout

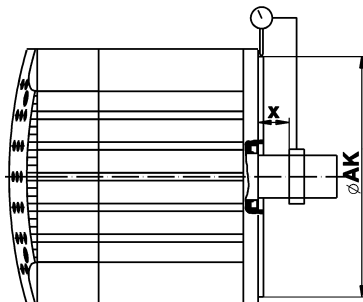

Koaxialität / concentricity

Figure 13: Concentricity

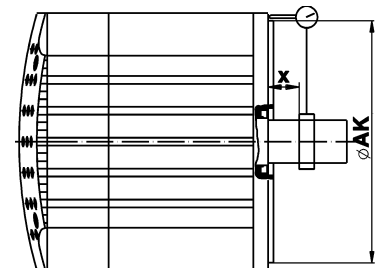

Planlauf / perpendicularity

Figure 14: Perpendicularity

Table 9: Flange Concentricity/Perpendicularity

Pilot Diameter of Mounting Flange $\phi AK$ [mm]	Maximum Concentricity and Perpendicularity Tolerance	
	Class R [mm]	Class N [mm]
to 22	0.025	0.050
over 22 to <40	0.030	0.060
40 to 100	0.040	0.080
over 100 to 230	0.050	0.100
over 230 to 450	0.063	0.125

## 3.2 TECHNICAL MOTOR DATA

### 3.2.1 STANDARDS FOR MOOG MOTORS

The brushless MOOG Global series servomotors have been designed, assembled and tested in conformity with the following standards:

Table 10: Motor design standards

Standard	International	Europe	Deutschland	USA
English	<b>IEC International Electrotechnical Commission</b>	<b>EN CENELEC</b> Europäisches Komitee für Elektrotechnische Normung	<b>DIN / VDE Deutsche Industrie Norm / Verband Deutscher Elektrotechniker</b>	<b>NEMA / NEC</b> National Electric Code MG.-...
Certified company	ISO 9001	EN ISO 9001	DIN ISO 9001	ISO 9001
Quality systems - model for quality assurance in design / development, production, installation and servicing	ISO 9001	EN ISO 9001	DIN ISO 9001	ISO 9001
Machine guidelines (CE Machine safety directive)	89/392/EWG, 91/368/EWG, 93/44/EWG	89/392/EWG, 91/368/EWG, 93/44/EWG	89/392/EWG, 91/368/EWG, 93/44/EWG	
EMC guidelines (CE-EMC directive)	89/336/EWG, 93/68/EWG, 93/44/EWG	89/336/EWG, 93/68/EWG, 93/44/EWG	89/336/EWG, 93/68/EWG, 93/44/EWG	
Low voltage guidelines (CE-Low voltage directive)	73/23/EWG, 93/68/EWG, 93/44/EWG	73/23/EWG, 93/68/EWG, 93/44/EWG	73/23/EWG, 93/68/EWG, 93/44/EWG	
Standard for safety of electric motors				UL 1004 (1994)
Safety of machinery, electrical equipment of machines, part 1: general requirements	IEC 204-1	EN 60204-1	DIN EN 60204-1 VDE 0113-1	

Table 11: Electrical Design Standards

Standard	International	Europe	Deutschland	USA
English	<b>IEC International Electrotechnical Commission</b>	<b>EN CENELEC</b> Europäisches Komitee für Elektrotechnische Normung	<b>DIN / VDE Deutsche Industrie Norm / Verband Deutscher Elektrotechniker</b>	<b>NEMA / NEC National Electric Code MG-...</b>
Rotating electrical machines, Rating and performance	IEC 34-1 IEC 2/915/CDV: 1995	EN 60034-1	DIN EN 60034-1 VDE 0530-1	MG 1-1.65
Rotating electrical machines, Methods for determining losses and efficiency and performance	IEC 2G/73/FDIS	EN 60034-2	DIN EN 60034-2 VDE 0530-2	
Rotating electrical machines, Classification of degrees of protection provided by enclosure	IEC 34-5	EN 60034-5	DIN EN 60034-5 VDE 0530-5	MG 1-1.25 MG 1-1.26
Rotating electrical machines, Methods of cooling (IC-Code)	IEC 34-6	EN 60034-6	DIN EN 60034-6 VDE 0530-6	MG 1-1.25 MG 1-1.26
Rotating electrical machines, Classification of types of construction and mounting arrangements (IM Code)	IEC 34-7	EN 60034-7	DIN EN 60034-7 VDE 0530-7	MG 1-4.03
Rotating electrical machines, Terminal markings and directions of rotation	IEC 34-8	EN 60034-8	DIN EN 60034-8 VDE 0530-8	MG 1-2.61
Rotating electrical machines, Noise limits	IEC 34-9	EN 60034-9	DIN EN 60034-9 VDE 0530-9	N/A.
Insulation coordination for equipment with low-voltage systems. Part 1: Principles, requirements and tests	IEC 664-1		VDE 0110-1	
Insulation coordinates for equipment with low-voltage systems. Part 2: Partial discharge tests, application guide	IEC 664-2		VDE 0110-2	
Connectors and plug-and-socket-devices, for rated voltages up to 1000 V AC, up to 1200 V DC and rated currents up to 500 A for each pole			DIN VDE 0627	

Table 12: Motor mechanical standards

Standard	International	Europe	Deutschland	USA
English	IEC International Electrotechnical Commission	EN CENELEC Europäisches Komitee für Elektrotechnische Normung	DIN / VDE Deutsche Industrie Norm / Verband Deutscher Elektrotechniker	NEMA / NEC National Electric Code MG-...
Degrees of protection provided by enclosure (IP code)	IEC 529	EN 60529	DIN EN 60529 VDE 0470-1	
Cylindrical shaft ends for electrical machines	IEC 72 ISO/R 775-1969		DIN 748-1 & 3	MG-11...
Mounting flanges for rotating electrical machinery			DIN 42948	
Dimensions, tolerances and mounting				NEMA MG-7
Tolerances of shaft extension run-out and of mounting flanges for rotating electrical machinery	IEC 72		DIN 42955	
Mechanical vibration, balance quality requirements of rigid rotors, determination of permissible residual unbalance	ISO 1940-1		DIN ISO 1940-1	
Mechanical vibration, balance quality requirements of rigid rotors, Balance errors	ISO 1940-2		DIN ISO 1940-2	
Ball bearings, conrad type, for electrical machines, tolerances and radial clearance			DIN 42966	
Drive type fastenings without taper action, parallel keys, keyways, deep pattern			DIN 6885-1	
ISO general purpose metric screw threads. Part 1 coarse pitch threads in diameter range 1 mm to 68 mm, nominal sizes	ISO 724		DIN 13-1	
General tolerances, tolerances for linear and angular dimensions without individual tolerance indications	ISO 2768-1	EN 22768	DIN ISO 2768-1	

### 3.2.2 MOTOR PERFORMANCE DATA

#### Operating and ambient conditions for G4xx and G33x motor series:

Temperature for Transport and Storage:	-40 °C to 120°C note ❶ -25 °C to 120 °C
Degree of Protection:	IP 67 with optional shaft seal or gearbox attached note ❷ (DIN VDE 0470-1, EN 60529, IEC 529)
Ambient temperature in Operation:	-25 °C to 50 °C
Runout:	Class R (DIN 42955-R, IEC72) note ❶ Class N (DIN 42955-N, IEC72)

note ❶ : G4xx motor series only

note ❷ : G33x motor series mating connector must be attached

#### Legend:

- ❶ Motor flanged mounted onto a steel plate 300 x 300 x 12 mm with the maximum permissible temperature rise of the winding at 100 K over a still air environment (max. 50 °C)
- ❷ Speed at which the EMF of the motor is equal to the DC-bus voltage
- ❸  $k_t = \frac{M_N}{I_N}$

#### conversions:

1 Nm = 8.85 lb-in

1 kgcm<sup>2</sup> = 8.85x10<sup>-4</sup> lb-in-sec<sup>2</sup>

1 kg = 2.2 lb

1 kW = 1.341 hp

Table 13: Motor Performance Stall Data G400 series

Motor type		Stall data					
		Continuous stall torque ❶		Continuous stall current ❶	Peak stall torque		Peak stall current
Model	Type	Mo [Nm]	Mo [lb-in]	Io [Arms]	Mmax [Nm]	Mmax [lb-in]	Imax [Arms]
note							
G4y2-2xx	G2L05	0.25	2.21	0.65	0.5	4.43	1.9
G4y2-4xx	G2L10	0.50	4.43	1.2	1.4	12.39	3.7
G4y2-6xx	G2L20	0.95	8.41	2.15	2.6	23.01	6.4
G4y2-8xx	G2L40	1.7	15.05	2.85	5	44.25	8.3
G4y3-2xx	G3L05	0.6	5.31	1.6	1.5	13.28	4.6
G4y3-4xx	G3L15	1.65	14.60	3.2	4.7	41.60	10.6
G4y3-6xx	G3L25	2.55	22.57	3.4	8.5	75.23	12.4
G4y3-8xx	G3L40	3.7	32.75	4.2	13	115.05	16.3
G4y4-2xx	G4L05	1.3	11.51	3.1	3.2	28.32	9
G4y4-4xx	G4L10	2.6	23.01	4.8	6.5	57.53	15
G4y4-6xx	G4L20	4.7	41.60	6.7	12.5	110.63	20
G4y4-8xx	G4L40	8.2	72.57	9.2	22	194.70	28
G4y4-9xx	G4L60	11	97.35	9.5	31	274.35	30
G4y5-2xx	G5L10	5.8	51.33	9.5	12.2	107.97	24
G4y5-4xx	G5L20	11.2	99.12	11	25.8	228.33	33
G4y5-6xx	G5L30	16.6	146.91	12.9	40	354.00	38
G4y5-8xx	G5L50	25	221.25	14.8	60	531.00	43

note: y = 1 US version; y = 2 Europe version

Table 14: Motor Performance Miscellaneous Data G400 series

Motor type		Miscellaneous data							
		Theoret. no load speed ②	Torque constant ③		rotor inertia without brake		Mass without brake		Poles (polepairs)
Model	Type	Ntheo [rpm]	kt [Nm/Arms]	kt [lb-in/Arms]	J [kgcm <sup>2</sup> ]	J [lb-in-sec <sup>2</sup> ]	m [kg]	m [lb]	
note									
G4y2-2xx	G2L05	10200	0.37	3.27	0.09	0.00008	1.0	2.20	8 (4)
G4y2-4xx	G2L10	9000	0.42	3.72	0.13	0.00012	1.2	2.64	8 (4)
G4y2-6xx	G2L20	7900	0.46	4.07	0.22	0.00019	1.5	3.30	8 (4)
G4y2-8xx	G2L40	6300	0.60	5.31	0.41	0.00036	2.3	5.06	8 (4)
G4y3-2xx	G3L05	9600	0.40	3.54	0.16	0.00014	1.4	3.08	8 (4)
G4y3-4xx	G3L15	7200	0.53	4.69	0.39	0.00035	2.0	4.40	8 (4)
G4y3-6xx	G3L25	4900	0.75	6.64	0.62	0.00055	2.6	5.72	8 (4)
G4y3-8xx	G3L40	4100	0.90	7.97	0.97	0.00086	3.5	7.70	8 (4)
G4y4-2xx	G4L05	8800	0.42	3.72	1.05	0.00093	3.0	6.60	12 (6)
G4y4-4xx	G4L10	6900	0.54	4.78	1.55	0.00137	3.6	7.92	12 (6)
G4y4-6xx	G4L20	5200	0.70	6.20	2.60	0.00230	4.7	10.34	12 (6)
G4y4-8xx	G4L40	4200	0.89	7.88	4.70	0.00416	6.9	15.18	12 (6)
G4y4-9xx	G4L60	3300	1.16	10.27	6.80	0.00602	9.1	20.02	12 (6)
G4y5-2xx	G5L10	6100	0.61	5.40	4.60	0.00407	7.7	16.94	12 (6)
G4y5-4xx	G5L20	3800	1.02	9.03	8.00	0.00708	9.9	21.78	12 (6)
G4y5-6xx	G5L30	3000	1.29	11.42	11.50	0.01018	12.1	26.62	12 (6)
G4y5-8xx	G5L50	2200	1.69	14.96	18.40	0.01628	16.6	36.52	12 (6)

note: y = 1 US version; y = 2 Europe version

Table 15: Motor Performance Stall Data G300 series

Motor type		Stall data					
		Continuous stall torque ④		Continuous stall current ④	Peak stall torque		Peak stall current
Model	Type	Mo [Nm]	Mo [lb-in]	Io [Arms]	Mmax [Nm]	Mmax [lb-in]	Imax [Arms]
G332-4xx	L2L10	0.5	4.43	1.15	1	8.85	2.3
G332-6xx	L2L20	0.95	8.41	2	1.9	16.82	4
G333-4xx	L3L15	1.6	14.16	3	3.2	28.32	6
G333-6xx	L3L25	2.6	23.01	3.3	5.2	46.02	6.6
G334-4xx	L4L10	2.5	22.13	4.5	4.7	41.60	9
G334-6xx	L4L20	5	44.25	7	9.4	83.19	14

Table 16: Motor Performance Miscellaneous Data G300 series

Motor type		Miscellaneous data							
		Theoret. no load speed ②	Torque constant ③		rotor inertia without brake		Mass without brake		Poles (polepairs)
Model	Type	Ntheo [rpm]	kt [Nm/Arms]	kt [lb-in/Arms]	J [kgcm <sup>2</sup> ]	J [lb-in-sec <sup>2</sup> ]	m [kg]	m [lb]	
G332-4xx	L2L10	9000	0.44	3.89	0.13	0.00012	1.2	2.64	8 (4)
G332-6xx	L2L20	7900	0.49	4.34	0.22	0.00019	1.5	3.30	8 (4)
G333-4xx	L3L15	7200	0.55	4.87	0.37	0.00033	2	4.40	8 (4)
G333-6xx	L3L25	4900	0.8	7.08	0.59	0.00052	2.6	5.72	8 (4)
G334-4xx	L4L10	6900	0.58	5.13	1.5	0.00133	3.6	7.92	12 (6)
G334-6xx	L4L20	5200	0.76	6.73	2.5	0.00221	4.7	10.34	12 (6)

### 3.2.3 TORQUE SPEED CHARACTERISTIC G400 SERIES MOTORS

Legend:

- ① torque limit for continuous operation (winding 100 K above ambient, with motor mounted to 300mm x 300mm x 12mm steel plate)
- ② peak torque at approx. three times continuous stall current with L180 controller (higher torque at higher current levels possible)
- ③ kt-line gives torque at current level (top axis)

#### Drive System L180 - Servomotor G4x2

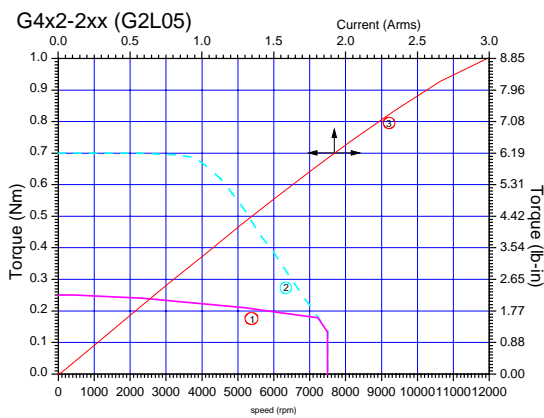

Figure 15: Torque-Speed Char. G2L05

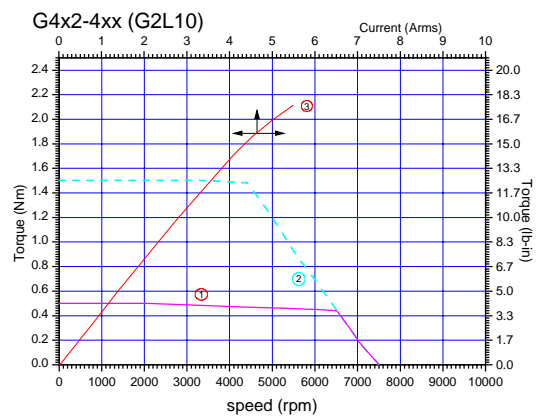

Figure 16: Torque-Speed Char. G2L10

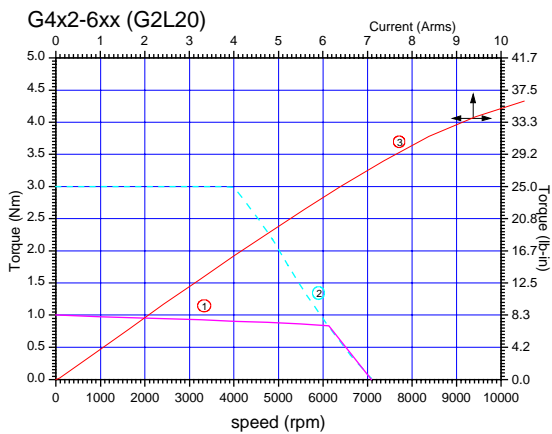

Figure 17: Torque-Speed Char. G2L20

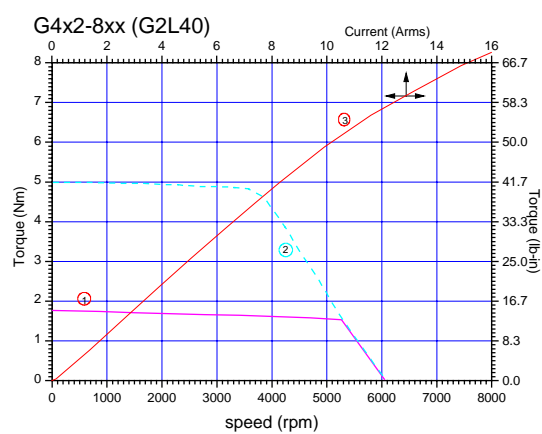

Figure 18: Torque-Speed Char. G2L40

#### Drive System L180 - Servomotor G4x3

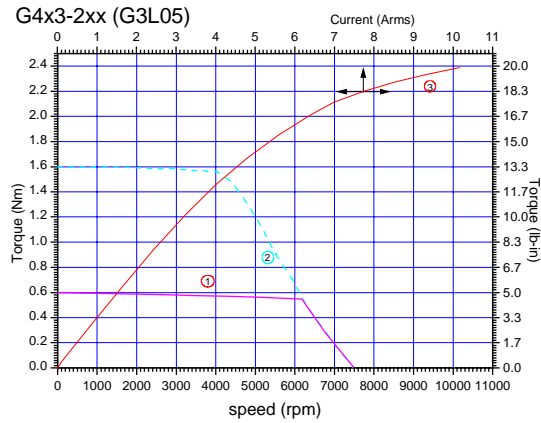

Figure 19: Torque-Speed Char. G3L05

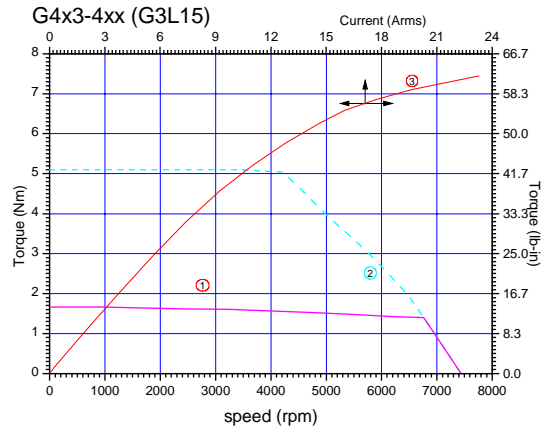

Figure 20: Torque-Speed Char. G3L15

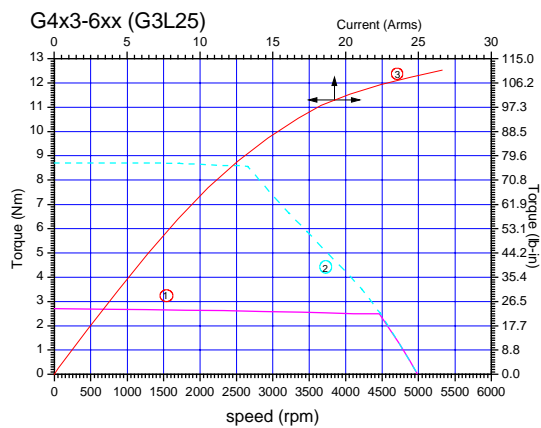

Figure 21: Torque-Speed Char. G3L25

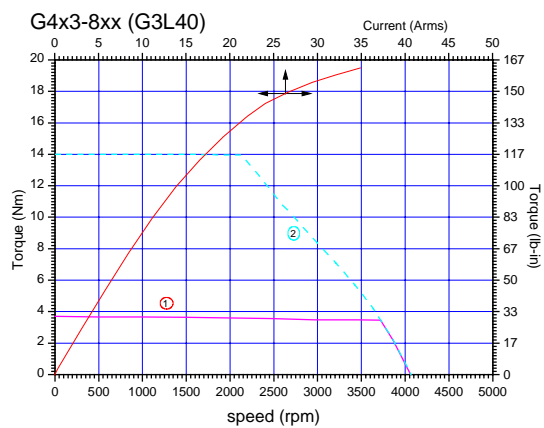

Figure 22: Torque-Speed Char. G3L40



Drive System L180 - Servomotor G4x4

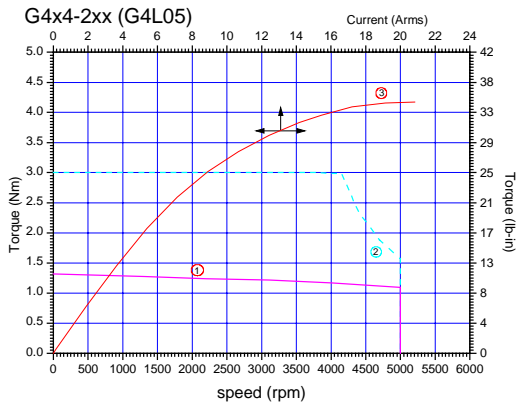

Figure 23: Torque-Speed Char. G4L05

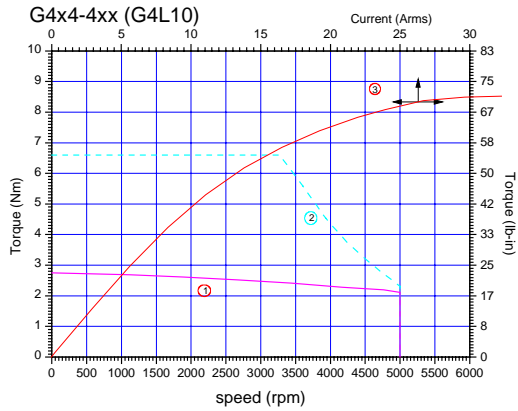

Figure 24: Torque-Speed Char. G4L10

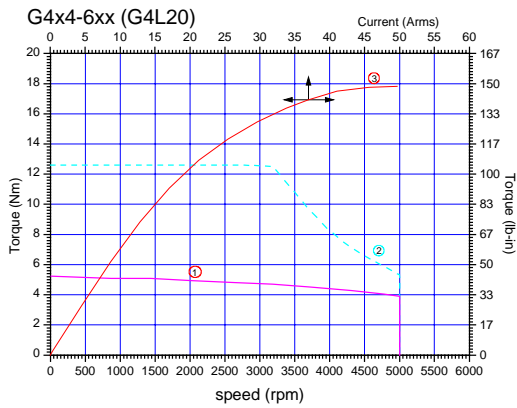

Figure 25: Torque-Speed Char. G4L20

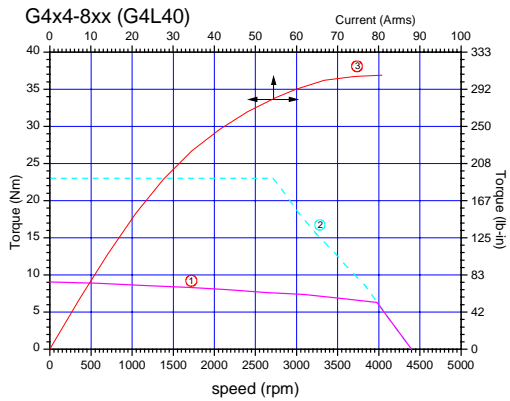

Figure 26: Torque-Speed Char. G4L40

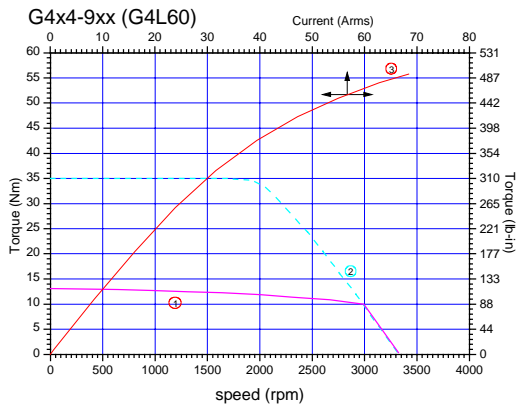

Figure 27: Torque-Speed Char. G4L60

#### Drive System L180 - Servomotor G4x5

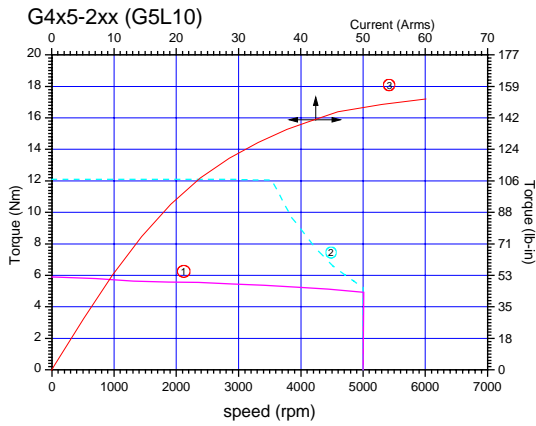

Figure 28: Torque-Speed Char. G5L10

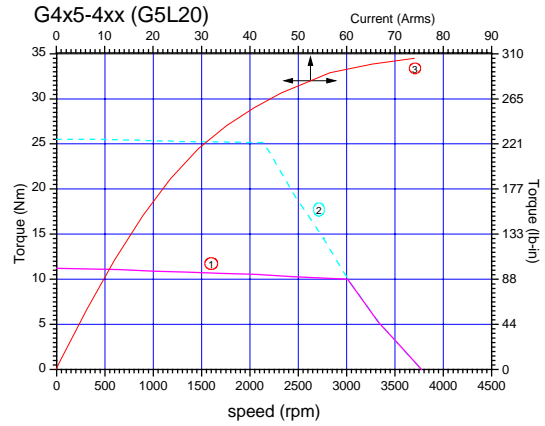

Figure 29: Torque-Speed Char. G5L20

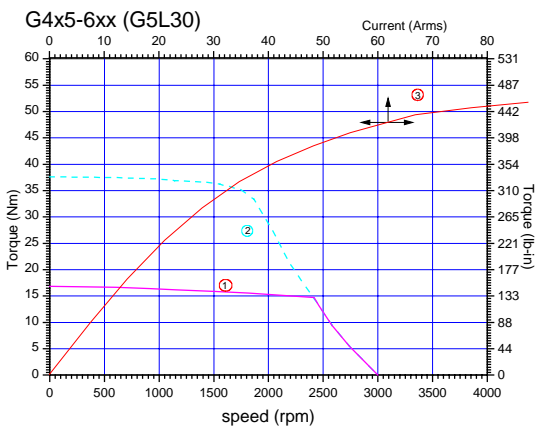

Figure 30: Torque-Speed Char. G5L30

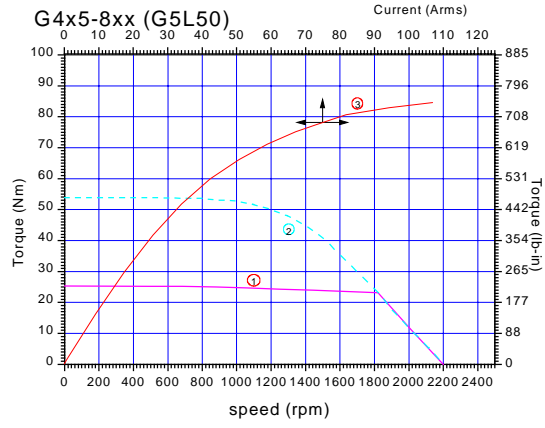

Figure 31: Torque-Speed Char. G5L50

### 3.2.4 TORQUE-SPEED-CHARACTERISTICS G300 SERIES MOTORS

Legend:

- ① torque limit for continuous operation (winding 100 K above ambient, with motor mounted to 300mm x 300mm x 12mm steel plate)
- ② peak torque at approx. two times continuous stall current with L180 controller
- ③ kt-line gives torque at current level (top axis)

#### Drive System L180 - Servomotor G332

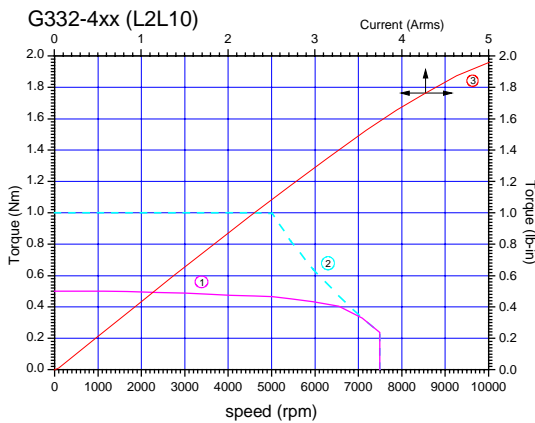

Figure 32: Torque-Speed Char. L2L10

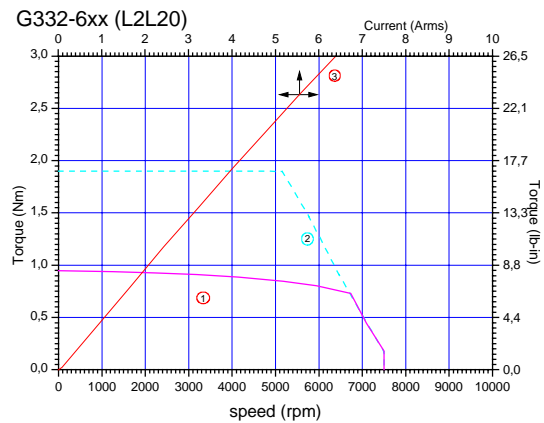

Figure 33: Torque-Speed Char. L2L20

#### Drive System L180 - Servomotor G333

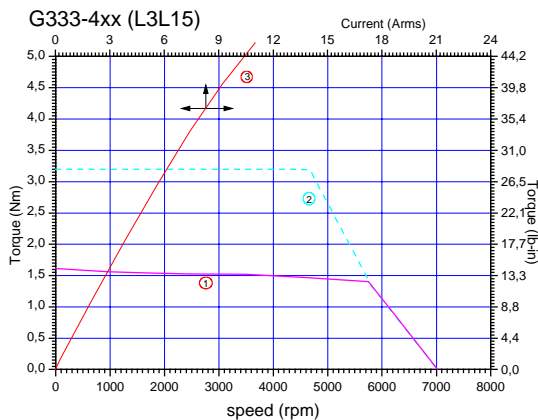

Figure 34: Torque-Speed Char. L3L15

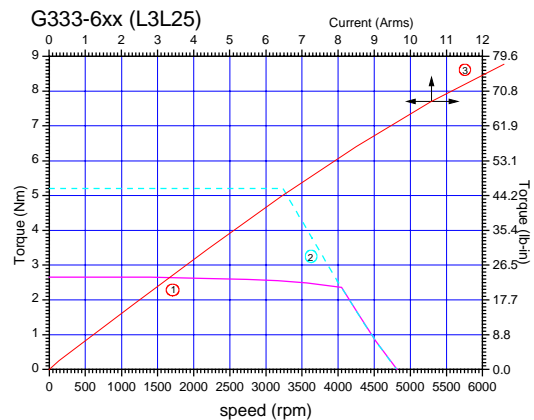

Figure 35: Torque-Speed Char. L3L25

#### Drive System L180 - Servomotor G334

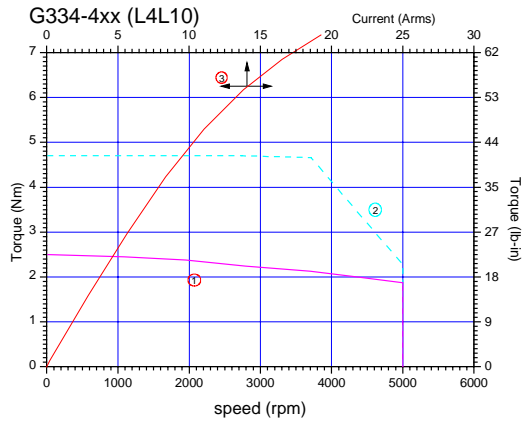

Figure 36: Torque-Speed Char. L4L10

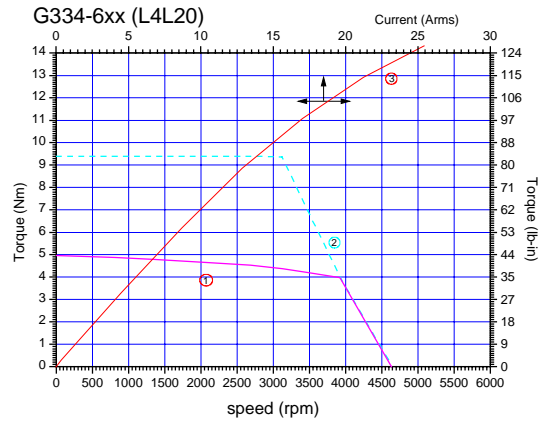

Figure 37: Torque-Speed Char. L4L20

### 3.2.5 MOTOR BRAKE DATA

The following is the specification data for the G4xx motor brakes. Options are specified in the motor box-car drawing. A regulated DC power supply is recommended.

Table 17: G4xx Motor Brake Data

Parameter		G4x2 Series Brake	G4x3 Series Brakes		G4x4 Series Brakes		G4x5 Series Brakes	
			Option 1	Option 2	Option 1	Option 2	Option 1	Option 2
Rated Braking Holding Torque	[Nm]	0.9	1.5	3.0	6.0	15.0	15.0	25.0
	[lb-in]	7.97	13.28	26.55	53.10	132.75	132.75	221.25
Inertia	[kg cm <sup>2</sup> ]	0.02	0.07	0.18	0.54	1.00	1.00	3.6
	[lb-in-sec <sup>2</sup> ]	0.00002	0.00006	0.00016	0.00048	0.00089	0.00089	0.00319
Rated Voltage	[V]	24 +/-15%	24 +/-15%	24 +/-15%	24 +/-15%	24 +/-15%	24 +/-15%	24 +/-15%
Power Consumption at 20 °C (68 F)	[W]	11	11	10	13	19	19	24
Time to Disengage, t <sub>1</sub>	[ms]	20	20	20	30	50	50	80
Time to Engage, t <sub>2</sub>	[ms]	15	15	15	25	35	35	40
Current at 24 VDC to release	[A]	0.46	0.46	0.42	0.54	0.79	0.79	1.0

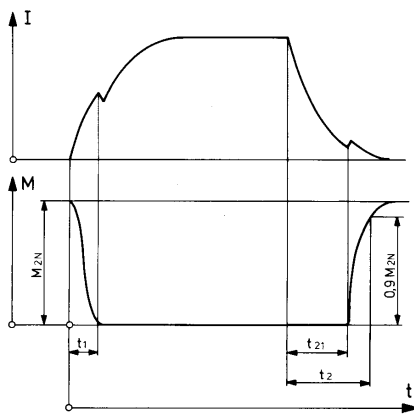

t<sub>1</sub> switch-on time  
t<sub>21</sub> switch-off delay  
t<sub>2</sub> switch-off time  
I<sub>N</sub> rated magnet current  
M<sub>2N</sub> nominal torque

Average switching times with nominal air gap (ms)

Figure 38: Current/time and torque/time diagrams



## 4 INSTALLATION

---

This chapter on installation refers to L180 servo drives series. The wiring of the L180 servo drive must be carried out according to the schematics in these instructions. Local wiring regulation must be observed. Special attention should be paid with respect to wiring rules regarding ground, earth and neutral. The earth wire to the drive, motor and housing must be as short as possible and connected to a common earth point.

### 4.1 WIRING

---

The following is a general reminder of the cable requirements for the L180 servo drive series and related equipment.

Cabling and component wiring is critical in obtaining successful operation of the system. Pay close attention to specified wiring practice, cabling information, earth and shielding requirements. Improper wiring can result in electrical noise generation and unstable motor performance.

Size wire in accordance with standard wiring practice and local codes for amperage and wire length.

Particular care should be taken when layout of a cabinet is designed. Efforts to separate routing of signal and power wires should be taken. The following guidelines should be taken into account:

- Separate signal and power cable for low noise emission
- Minimize of radiated interference by using of shielded signal cables
- Signal cable should cross power cable at an angle of 90°. This reduces field coupling which causes noise.

All electrical supply wires and cables to this equipment must be installed in conduits (cable routings) which are smooth and free from sharp edges.

## 4.2 CONNECTOR OVERVIEW

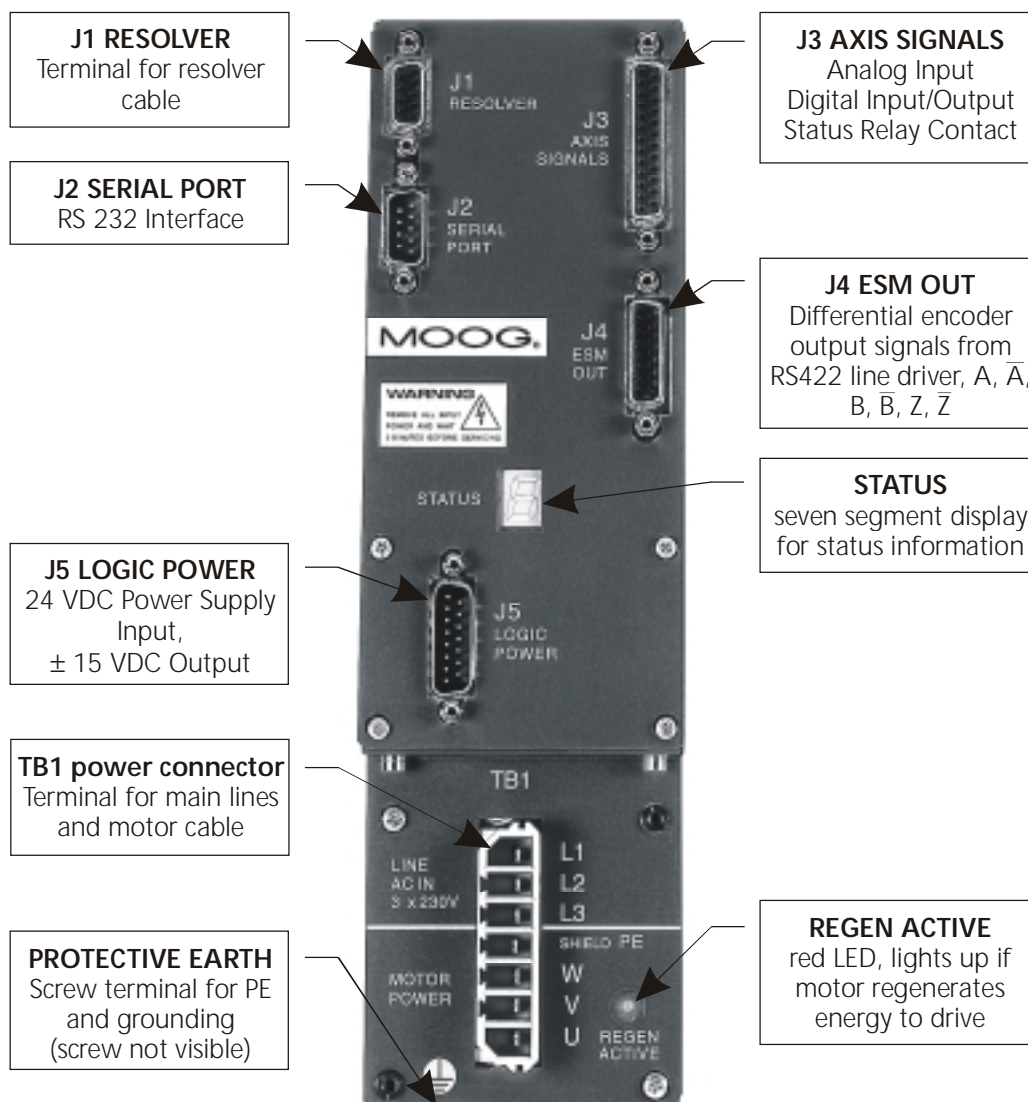

Figure 39: Wiring Overview



### WARNING

The PE terminal of the drive must be permanently connected to the earth potential. The cross-section of the protective conductor must be at least **4mm<sup>2</sup> (AWG 10)** copper (Cu).



### 4.2.1 MOTOR AND POWER CONNECTOR TB1

The servo drive unit can be operated with either a single-phase or three-phase AC voltage.

Table 18: Main line voltage

	Unit	Minimum	Regular	Maximum
Mains frequency	Hz	45	50/60	65
Supply Voltage	VAC	184	230	253



#### WARNING

A three phase automatic circuit breaker must be used for three phase operation in order to ensure that all phases are tripped at the same time in the event of a fault! The wire protection must be taken into account. This depends on the cross-section of the main line wires. Please refer to your local regulations for detailed information.

#### Single phase operation

TB1:L1	In single phase operation, the voltage between live and neutral is 230 VAC. The phase line should be connected to TB1:L1 and the neutral line to TB1:L2. The protective earth conductor must also be connected to the earth stud on the drive.
TB1:L2	

#### Three phase operation

TB1:L1	The nominal voltage between the servo drive unit terminals must be equal to 230 VAC. The phase-to-phase voltage of a normal 3-phase 400 VAC (440 VAC) mains supply must be stepped down to 230 VAC by means of an auto or isolation transformer connected to terminal TB1. The protective earth conductor must be connected to the earth stud on the drive.
TB1:L2	
TB1:L3	

#### Transformer

The selection of the transformer size depends on the ambient conditions, duty cycle and power requirements of the application. Two or more drives can be connected to one transformer. The transformer must deliver the maximum current. In any case of uncertainty do not hesitate to contact your local application engineer.

#### Additional Parts for the drive system

Additional fuses for transformer and wiring protection have to be installed according to the local regulations. The transformer protection should be clarified with the transformer supplier. Contactors are to be used where necessary. Examples of contactor use include: emergency stop and on/off circuits. A main power switch may also be necessary because of local regulations.

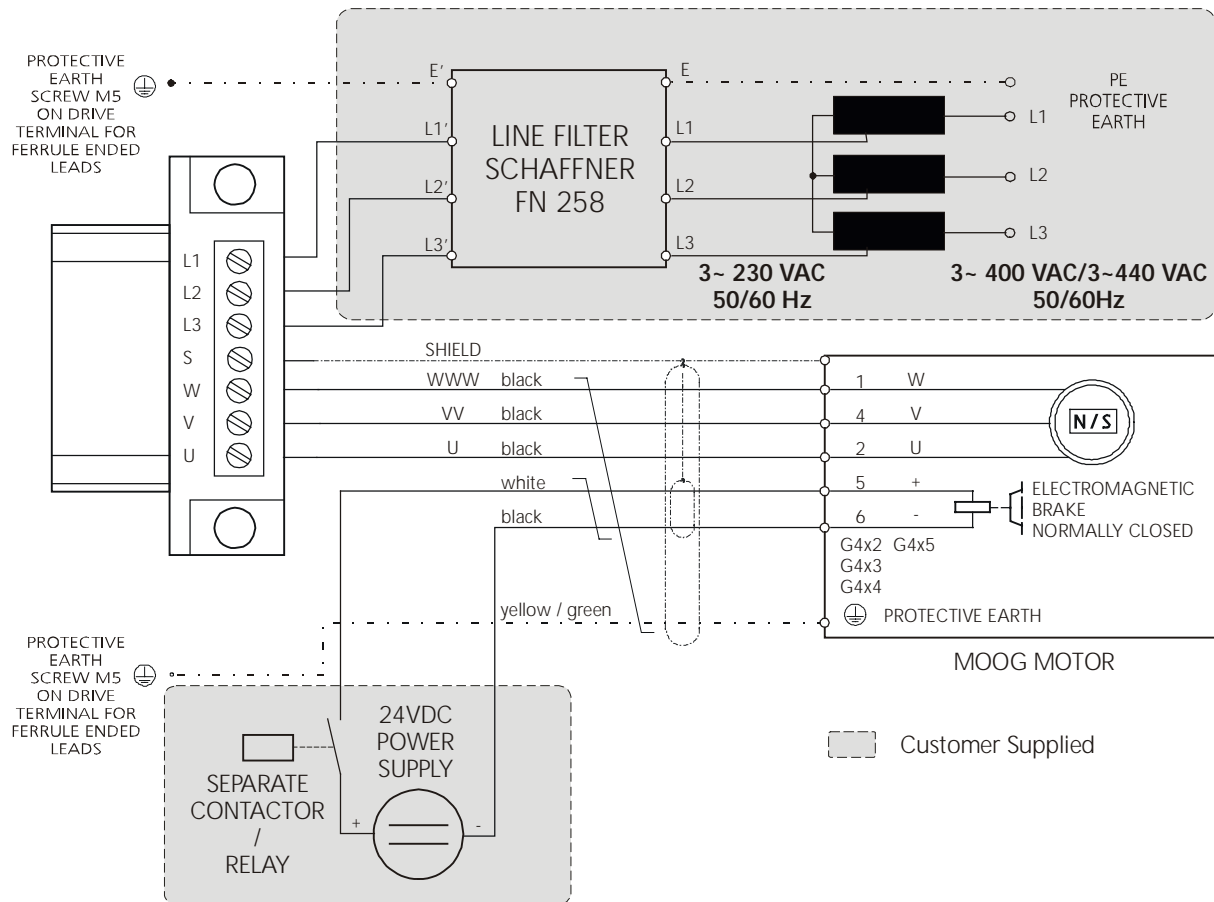

Figure 40: TBI Wiring

### Brake

The brake is released with 24 VDC. This voltage must be provided and controlled by an auxiliary power supply. The L180 servo drive does not support any brake control. The brake is designed for static holding applications where the shaft is held during disabling of the drive. If the brake is used for dynamic braking several times, it will become worn and the braking effect will deteriorate. The brake is not designed to replace safety functions.

### Customer supplied parts

MOOG can not accept any warranty of customer supplied components even when they are necessary for the operating system.

### Maximum Cable length

The maximum cable length from servo drive to motor is 100 m (328 ft).



**WARNING**

The motor must be wired and tested consistent to this manual.

- **Power cable**

An incorrect phase sequence can cause the motor to accelerate in an uncontrolled manner upon enabling the drive.

Sufficient line filter for a single axis application is shown in the table below.

Table 19: EMC Filter

	L180-310A	L180-410A	L180-510A
line filters	FN 258-7	FN 258-16	FN 258-16



**CE-COMPLIANCE**

**EMC-FILTER**

A line filter must be installed between the drive and the main transformer otherwise CE conformity is not guaranteed. The table above shows appropriate line filters manufactured by Schaffner, Switzerland. All EMC measurements were done with these filters. Only one line filter need be used if more than one drive is connected to the transformer. The current of the filter has to meet the overall current of the drive arrangement.

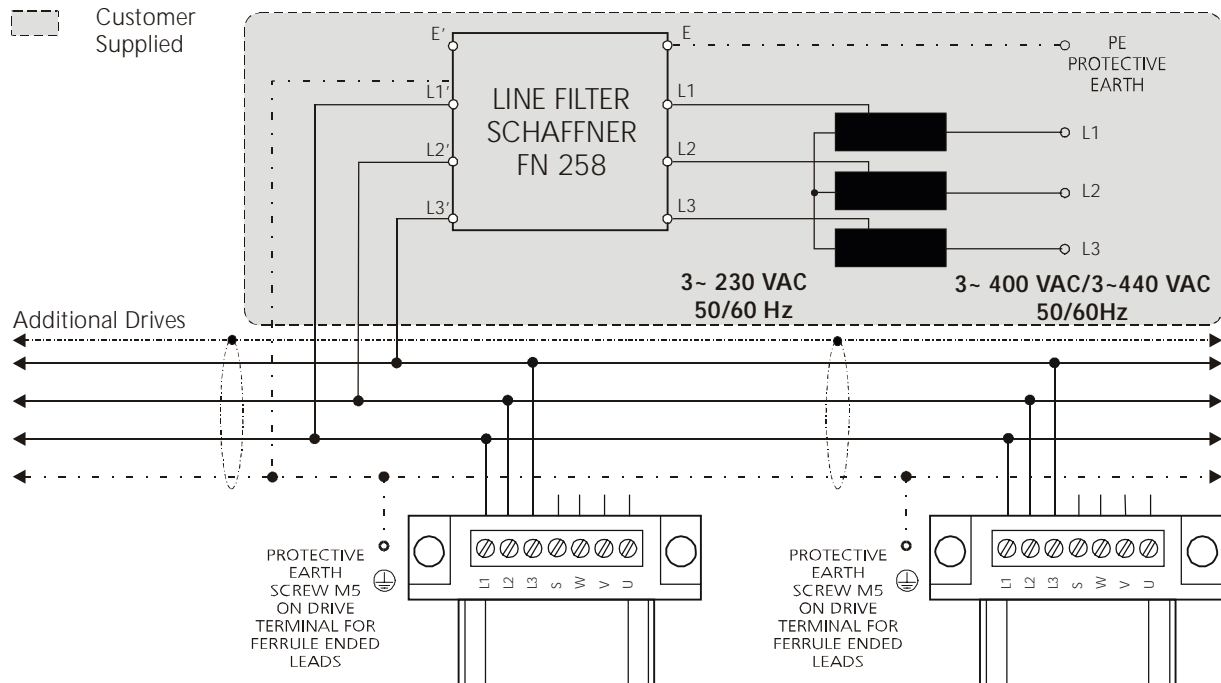

Figure 41: Multi Axis Wiring

#### 4.2.1.1 TB1 POWER CONNECTOR PINOUT

Table 20: TB1 power connector pinout

TB1 power connector				MOOG motors pin number	
pin number	pin name	function	pin type	Gxx2, Gxx3, Gxx4	G4x5
L1,L2,L3	L1,L2,L3	main line terminal 3~ 230 VAC	power input	-	-
S	Shield PE	motor cable shield	PE potential	shield	shield
W	W	motor phase W (C)	power output	1	W
V	V	motor phase V (B)	power output	4	V
U	U	motor phase U (A)	power output	2	U

#### 4.2.1.2 ACCESSORY POWER PART

##### General Cable Specification

Designed for use in cable tracks, as tailing cable and oil environment, temperature range: -50 °C to 90 °C continuous operation (-58 °F to 194 °F), 150 °C (302 °F) maximum temperature, bending cycles > 1 million, bend radius for cable chain > 12 x outer diameter

Table 21: Accessory parts power connector

Part	Part Number	Motor	Description
Drive mating power connector	<b>C08474-001</b>	all drives	Mating power connector for all drives. Supplied with each drive, spare part. Type Weidmueller STVS 7 SB, cross-sectional area 0.5 - 4 mm <sup>2</sup> , 20 - 12 AWG.
Raw Power Cable note ❶	<b>B47890-001</b>	Gxx2, Gxx3, Gxx4	Shielded cable for customer configuration, 4 x 1.5 mm <sup>2</sup> power leads, 2 x 1 mm <sup>2</sup> brake leads, outer shield
Raw Power Cable note ❶	<b>B47903-001</b>	G4x5	Shielded cable for customer configuration, 4 x 2.5 mm <sup>2</sup> power leads, 2 x 1 mm <sup>2</sup> brake leads, outer shield
Motor Power Connector	<b>C08365-001</b>	Gxx2, Gxx3, Gxx4	Power connector for customer configuration
Motor Power Connector	<b>B47736-001</b>	G4x5	Power connector for customer configuration
Motor Power Cable	<b>C08336-001-xxx</b> note ❷	Gxx2, Gxx3, Gxx4	Prefabricated motor cable with mating motor connector and ferrule ended leads, 4 x 1.5 mm <sup>2</sup> power leads, 2 x 1 mm <sup>2</sup> brake leads, outer shield
Motor Power Cable	<b>B47915-001-xxx</b> note ❷	G4x5	Prefabricated motor cable with mating motor connector and ferrule ended leads, 4 x 2.5 mm <sup>2</sup> power leads, 2 x 1 mm <sup>2</sup> brake leads, outer shield

note ❶: consult local sales office

note ❷: xxx length in meter

#### 4.2.2 RESOLVER CONNECTOR J1

Correct wiring of the resolver is necessary for reliable operation of the L180 servo drive. Non-compliance with the instructions in this manual will cause **a deterioration of specified performance.**

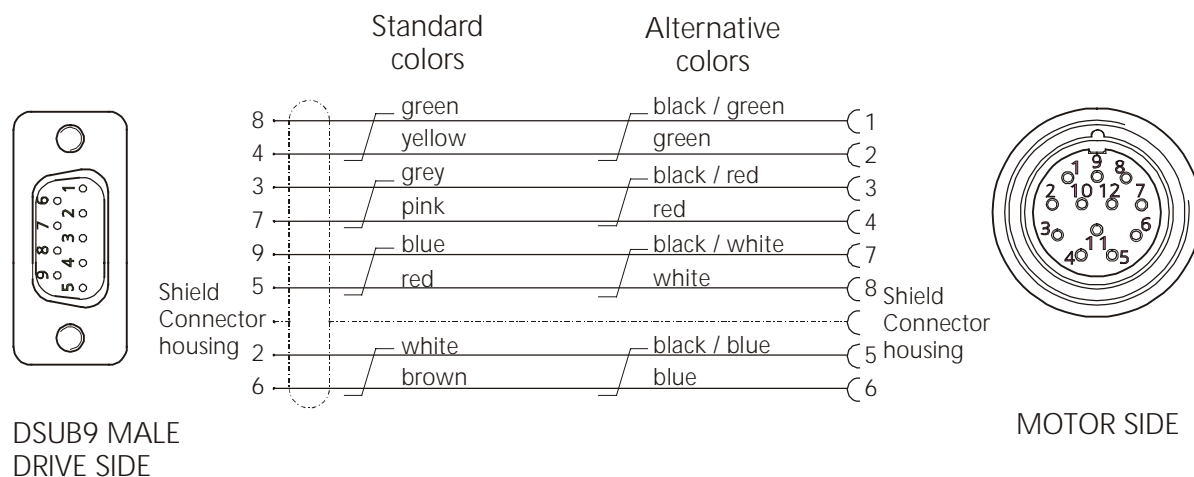

Figure 42: Resolver wiring, DSUB 9 male cable to J1

The overall shield must be connected to both the motor and the servo drive. The proper bonding of shielded cables is imperative for minimizing noise emissions and increasing immunity levels of the drive system. It should be noted that the contact from the overall shield to servo drive and motor must be made by using as much contact area as possible. It is recommended to follow the convention (signal / conductor color) used in this manual.

Table 22: J1 Resolver connector pinout

J1 RESOLVER				MOOG motors
pin number	pin name	function	pin type	pin number
1		do not connect		not connected
2	TH.MOT1 NTC	NTC motor thermistor	input	5
3	SIN S2	resolver feedback sine	input	3
4	COS S3	resolver feedback cosine	input	2
5	REFOUT R2	resolver reference, negative	output	8
6	TH.MOT2 NTC	NTC motor thermistor	input	6
7	SIN2V5 S4	resolver feedback sine	input	4
8	COS2V5 S1	resolver feedback cosine	input	1
9	REFOUT R1	resolver reference, positive	output	7



**WARNING**

The motor must be wired and tested consistent to this manual.

- **Signal cable**

Incorrect connection of the leads can cause the motor to accelerate in an uncontrolled manner when the drive is enabled. Any broken wire of the NTC connection means a loss of the thermal motor protection. The drive monitors the NTC resistor value and determines if it is above or below 4.2 kΩ. The resistor value is interpreted as motor temperature below or above 155°C (insulation class F). A secure connection must be ensured.

**4.2.2.1 ACCESSORY RESOLVER PARTS**

Table 23: Resolver parts

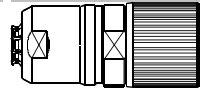
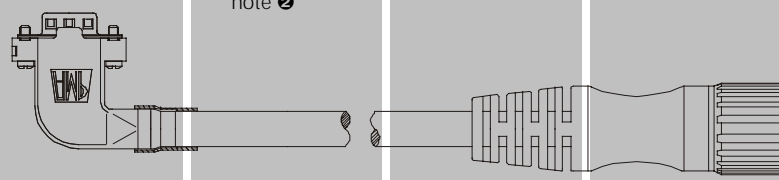
Part	Part Number	Motor	Description
Raw signal cable note ❶	<b>B47885-001</b>	all motors	 <p>7.0 mm</p> <p>Shielded cable for customer configuration, 4 x 2 x 0.25 mm<sup>2</sup> leads, stranded wires, twisted paired, outer shield</p>
Motor mating signal connector	<b>C08309-001</b>	all motors	 <p>Signal connector for customer configuration</p>
Signal Cable	<b>C08335-003-xxx</b> note ❷	all motors	 <p>Prefabricated signal cable with mating drive and motor connectors. Mating connector in angular style with orientation to the top of the drive, 4 x 2 x 0.25 mm<sup>2</sup> leads, stranded wires, twisted paired, outer shield</p>

note ❶: consult local sales office

note ❷: xxx length in meter

**General Cable Specification**

Designed for use in cable tracks, as tailing cable and oil environment, temperature range: -50 °C to 90 °C continuous operation (-58 °F to 194 °F), 150 °C (302 °F) maximum temperature, bending cycles > 1 million, bend radius for cable chain > 12 x outer diameter

**Maximum Cable length**

The maximum cable length from servo drive to motor is 100 m (328 ft).

#### 4.2.3 SERIAL PORT CONNECTOR J2

The serial link is used to set or monitor drive parameters stored in non-volatile memory using the configuration program. The serial link can also be used to perform firmware revisions.

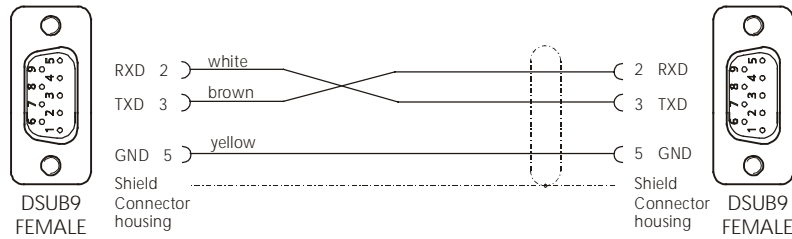

Figure 43: Serial link wiring, DSUB9 female cable to J2 and PC

Table 24: Wiring

J2 SERIAL PORT				PC
pin number	pin name	function	pin type	pin number
1,4,6,7,8,9		do not connect		
2	RX232	receive data line	input	3
3	TX232	transmit data line	output	2
5	GND	common ground		5

The serial port is operating in full duplex mode at a fixed baud rate of 9600 bit/sec. with the format listed below.

Table 25: Serial Protocol

Start bit	Data bit	Parity	Stop bit
1	8	no	1

A ready-to-connect cable is available with the following configuration.

Table 26: Serial Cable

Part	Part Number	Length	Description
Serial Port RS232 cable	C08475-001	5m	Prefabricated Commissioning cable between PC and each drive, 4 x 2 x 0.25 mm <sup>2</sup> leads, stranded wires, twisted paired, outer shield



#### 4.2.4 AXIS SIGNALS CONNECTOR J3

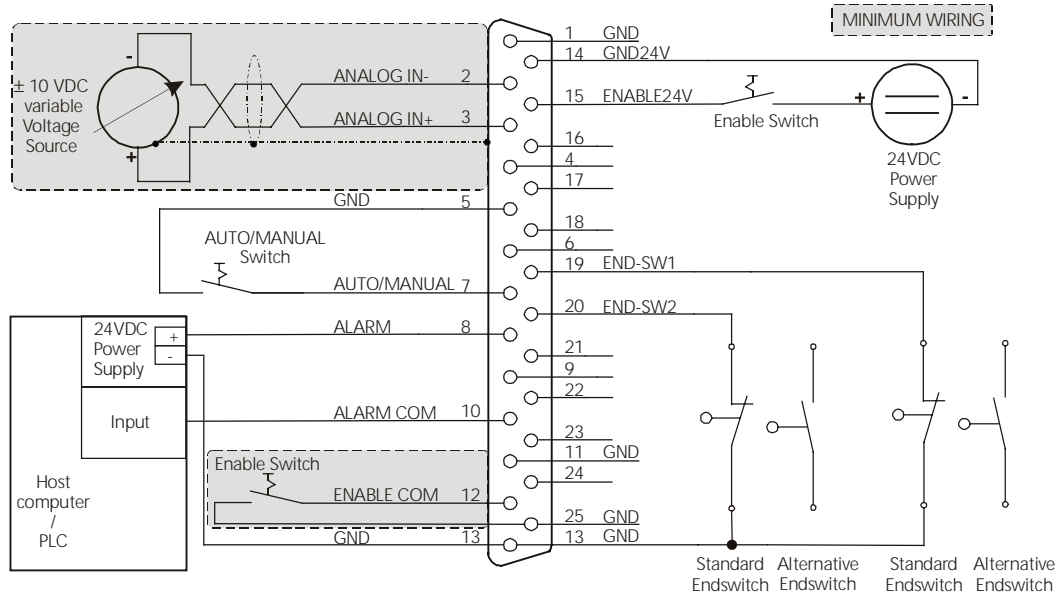

Figure 44: J3 Axis Signals Wiring, DSUB25 male cable to J3

Table 27: J3 Pin out

J3 Axis Signals				
pin number	pin name	function	specification	pin type
4, 6, 9, 16, 17, 18, 21, 22, 23, 24		do not connect		
1, 5, 11, 13, 25	GND	general purpose ground for digital input, output and reference for analog in		ground
2	ANALOG IN -	negative differential input command	max. differential input voltage +- 10 VDC, differential input impedance 8kΩ	analog input
3	ANALOG IN +	positive differential input command	max. differential input voltage +- 10 VDC, differential input impedance 8kΩ	analog input
7	AUTO/MANUAL	digital input for current limitation to the adjusted value	internal pull-up resistor 4.7 kΩ to 5 VDC	digital input
8, 10	ALARM, ALARM COM	potetial free n. o. contact for the adjustable alarm, ready relay	24 VDC, 0.5 A, 10VA	relay contact
12	ENABLE COM	passive enable, connecting to ground via any contact enables the drive.	internal pull-up resistor 4.7 kΩ to 5 VDC	digital input
14	GND 24V	ground of the active optocoupled ENABLE	potential free, max. 50 VDC to GND	external ground
15	ENABLE 24V	active optocoupled ENABLE	max. input voltage 30 VDC to GND 24V potential free, max. 50 VDC to GND active level 20 - 30 VDC / 5kΩ	input
19	END-SW1	limit switch input affecting the positive analog command	internal pull-up resistor 4.7 kΩ to 5 VDC	digital input
20	END-SW2	limit switch input affecting the negative analog command	internal pull-up resistor 4.7 kΩ to 5 VDC	digital input

#### ANALOG IN

<p>J3:2 ANALOG IN - J3:3 ANALOG IN +</p>	<p>This function has to be wired. Common mode voltage range (CMVR) +/-10V if common on ANALOG IN. The scaling of the analog input is programmable in speed mode.</p> <p>Drives with firmware revision A1 (firmware C08500-001) are fixed in current mode to the maximum drive current, e.g. 10VDC input on a L180-310A drive corresponds with 10 Arms.</p> $V_{IN} = \pm \frac{I_{\max,motor}}{I_{\max,drive}} \cdot 10VDC$ <p>If a motor is used with less than the maximum drive current the available voltage range of the analog input is reduced, e.g. 15 Arms maximum motor current leads to an analog input voltage range of ± 7.5 V at a drive with 20 Arms maximum drive current. The drive is not delivering more current than programmed.</p> <p>Drives with firmware revision A2 (firmware C08500-002) are scaled to the maximum motor current (parameter 3) on the analog input. A positive command leads to a clockwise rotation when viewed from the shaft side. A negative command leads to a counter-clockwise rotation when viewed from the shaft side( Definition of sense of rotation see Figure 78).</p>
--	---

#### AUTO/MANUAL

<p>J3:7 AUTO/MANUAL GND</p>	<p>This function is programmable in the L180GUI and need not be wired. The AUTO/MANUAL mode selection with pin 7 is a protection designed for the commissioning phase of the drive. An open contact selects the MANUAL mode.</p> <p>Drives with firmware revision A1 (firmware C08500-001) limits the current of the drive to the preconfigured value, therefore only limited motor torque is available. This feature offers no speed limitation.</p> <p>Drives with firmware revision A2 (firmware C08500-002) limits the current and speed of the drive to the preconfigured value, therefore only limited motor torque and speed is available.</p> <p>A closed contact to ground selects the AUTO mode with full drive capability. The MANUAL limit values are programmable and could also be set to the maximum motor current and speed, thus the AUTO/MANUAL mode selection is superfluous.</p>
---------------------------------	--

#### Monitoring Relay

<p>J3:8 ALARM J3:10 ALARM COM</p>	<p>This function is programmable in the L180GUI. The monitoring relay can be used to supply drive status information to other devices such as a host computer, PLC, etc.</p>
---------------------------------------	--

---

#### Enable Options

---

J3:12 ENABLE COM GND	One of the following two cases must be used. The drive can be enabled either with a 24VDC differential between pins 14 and 15 (optical isolated) or with a relay contact (switch) on pin 12 to ground (GND). Both options are connected in <b>OR</b> function, if one of them is activated the drive is enabled. The power stage is enabled within two sample periods (< 300 $\mu$ s) after enable transition.
J3:14 GND 24V	
J3:15 ENABLE 24V	

---

#### Endswitch

---

J3:19 END-SW1	This function is programmable in the L180GU. Each combination (n.c., n.o.) of the Endswitch contacts could be used as shown in Figure 44 J3 Axis Signals Wiring. Close end switch to GND to inhibit or allow motor movement (dependent upon configuration).
J3:20 END-SW2	
GND	

---

#### Minimum Wiring

---

Only the ANALOG IN input and one of the Enable options have to be connected to operate the drive, other functions are programmable in the L180 GUI and can be set to values which make wiring unnecessary.

---

#### Ground

---

All pin ground's are connected together with protective earth. The grounds in Figure 44 J3 axis wiring are interchangeable and connected only to simplify the drawing layout.

---

#### Galvanic isolation

---

The power module itself is isolated from the control circuits.

#### 4.2.5 ENCODER SIMULATION CONNECTOR J4

The Encoder simulation offers differential signals from a RS422 line driver which can be used for positioning purposes. The lines are driven with the internal power supply, thus no external voltage supply is necessary for the Encoder simulation. The figure below shows sufficient wiring. These signals are always present. A 120  $\Omega$  termination on the line receiver (motion controller) is recommended.

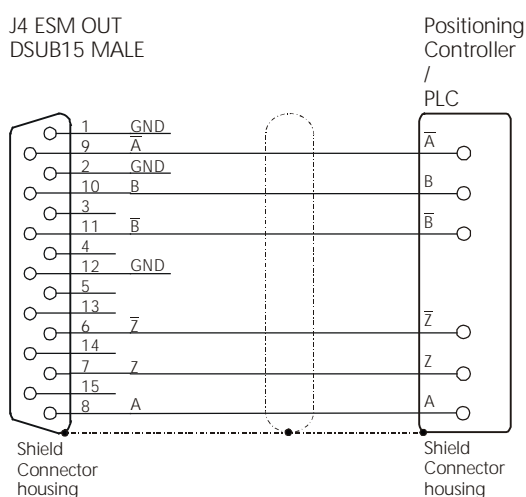

Figure 45: Encoder Output, DSUB15 male cable to J4

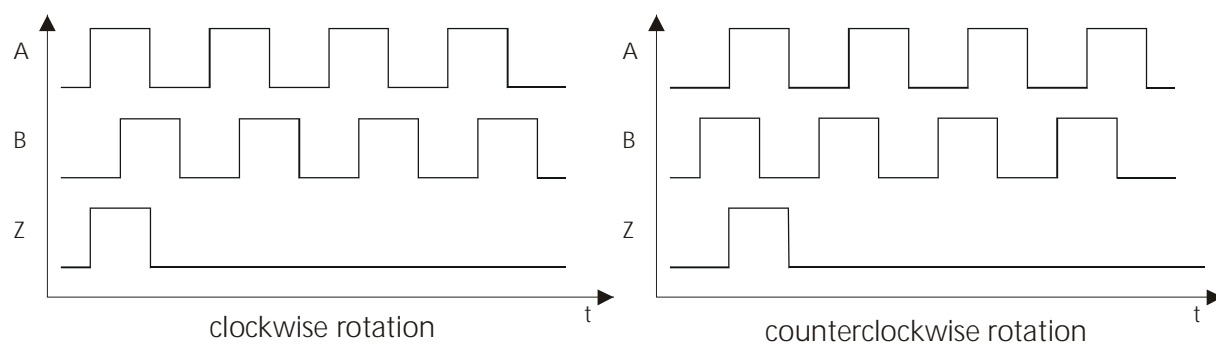

Figure 46: Definition of Encoder Signals, viewed from the shaft side

#### Cable

The maximum cable length is 20m (66 ft). The exact cable length is dependent on cable routing and system noise. A shielded cable with twisted pair is recommended to lower the signal distortion. Twisting Inverted and non inverted lines improves the robustness against noise sensitivity.

### Encoder Resolution

The resolution of the Encoder signals is programmable up to 2048 pulses per revolution (ppr). An extrapolated mode is used between 1025ppr and 2048ppr. The resolution up to 2048 is only available up to 6000rpm. At programmed speeds above 6000rpm only 1024ppr is accepted.

Table 28: J4 ESM out pinout

J4 ESM OUT			
pin number	pin name	function	pin type
3,4,5,13,14,15		do not connect	
1,2,12	GND	common ground	ground
6	$\bar{Z}$	inverted zero marker $\bar{Z}$	output
7	Z	zero marker Z	output
8	A	impulse A	output
9	$\bar{A}$	inverted impulse $\bar{A}$	output
10	B	impulse B	output
11	$\bar{B}$	inverted impulse $\bar{B}$	output

#### 4.2.6 LOGIC POWER CONNECTOR J5

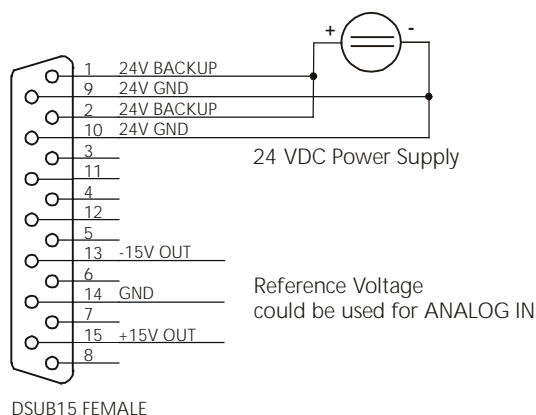

Figure 47: J5 Logic Power Wiring, DSUB15 female cable to J5

Table 29: J5 Logic Power pinout

J5 LOGIC POWER			
pin number	pin name	function	pin type
3,4,5,6,7,8,11,12		do not connect	
1	24 V BACKUP	+24 VDC backup supply	input
2	24 V BACKUP	+24 VDC backup supply	input
9	24V GND	24 VDC backup ground	input
10	24V GND	24 VDC backup ground	input
13	-15V OUT	-15 VDC supply	output
14	GND	15 VDC ground	output
15	+15 OUT	+15 VDC supply	output

#### 24V BACKUP

J5:1 24V Backup  
 J5:2 24V Backup  
 J5:9 24V GND  
 J5:10 24V GND

This voltage supply is optional and not required for the function of the servo drive. Serial port communication, parameter setting and drive configuration can be done with a backup voltage supply present, the main voltage is not necessary. In this case the drive shows an undervoltage indication on the seven segment display. The continuous input current is 0.5 Arms. The Input voltage range is 20-30VDC. An unregulated power supply is recommended.

#### ± 15VDC Supply

J5:13 -15V Out  
 J5:14 GND  
 J5:15 +15V Out

The ± 15VDC output voltage is only available if 24VDC backup voltage is applied. This output voltage can be used to generate an input command for the analog input. The continuous output current is 0.2 Arms. This output is protected against short circuit.

## 5 L180 GRAPHICAL USER INTERFACE

---

This section of the manual describes the use of L180 Graphical User Interface (L180GUI).

### 5.1 SYSTEM REQUIREMENTS

---

Minimum PC requirements	486 DX/2-66 processor 8MB RAM 6MB free on hard disk
Operating System	Windows 95, 98 or Windows NT Version 4.0 or later Windows 3.1 or later, with MS-DOS 3.1 or later (consult factory)
Video requirements	640x480 display A VGA resolution video adapter

### 5.2 GUI INSTALLATION

---

Like many Windows applications, this software must be installed by using the SETUP.EXE file, on the distribution disk. The SETUP can be executed from the file menu, file manager or from the Windows Explorer. This operation installs all libraries needed and the application icons. The distribution disk contains the L180GUI and motor parameter files. Please refer to the README file on the distribution disk for the latest information. The general procedure is as follows:

1. Start Windows.
2. Insert Disk 1 into PC disk drive A.
3. From the START or FILE MENU, choose RUN or double click on the SETUP.EXE in the FILE MANAGER or EXPLORER.
4. From the START or FILE MENU type A:\SETUP and press ENTER.
5. Follow the instructions on the screen.

A new program group and icons will be created. The group will be added to the program task bar under Windows 95/98/NT, or will be added as a group icon under Windows 3.1. Remove the L180GUI distribution disk. The L180GUI can be started by double clicking on the L180GUI icon. Please note that the full GUI functionality is only available with a serial link to the L180 servo drive.

The L180 GUI is also available for Windows 3.1(1) systems. An installation disk is provided on request. Please feel free to contact your local MOOG sales engineer, if required. The regular installation disk supports only Windows 95, 98, NT.

### 5.3 SYSTEM INFORMATION

Before getting started with the L180GUI the following information should be available or clarified:

1. Electrical model of the motor, displayed on the motor nameplate as Typ
2. Drive Size
3. Configuration of the end switch (End switches wired?)
4. Configuration of AUTO/MANUAL mode (AUTO/MANUAL wired?)
5. Configuration of the encoder simulation (Encoder Simulation wired?)

### 5.4 USING THE L180GUI

The L180GUI is a handy tool for parameter setting, control loop tuning and obtaining status drive information. The main window offers many features including useful toolbar buttons.

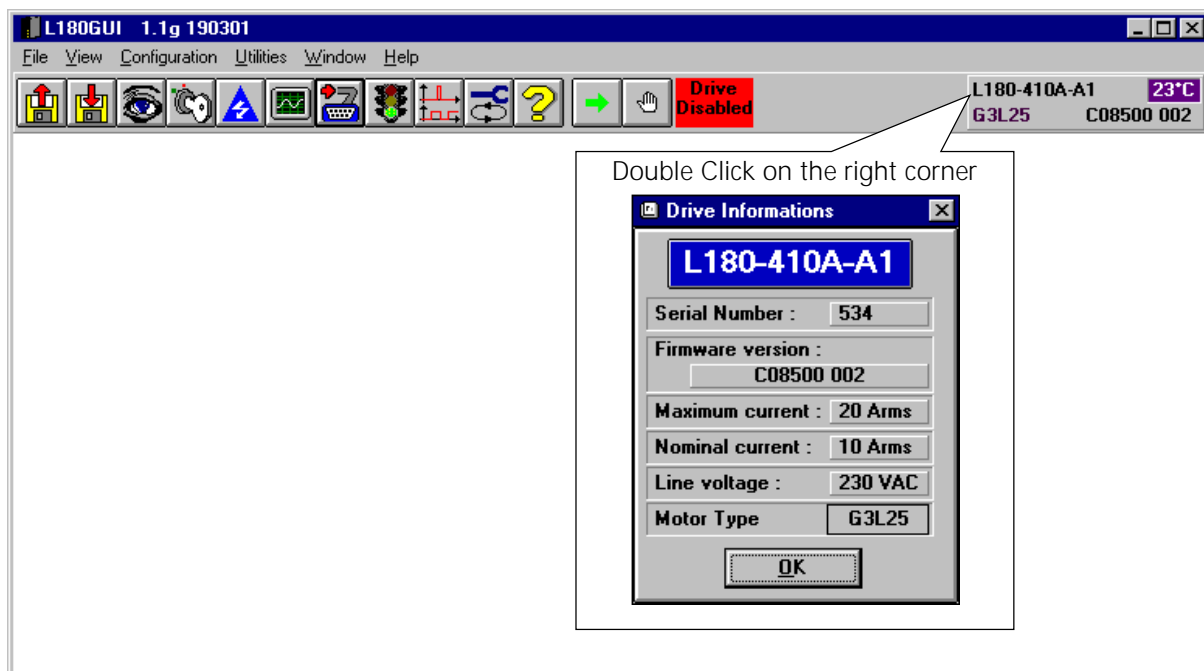

Figure 48: Main Window

The right hand corner of the main window shows the servo drive number (e.g. L180-510A-A1), the Firmware version (e.g. C08500 001), the electrical model of the motor (Motor Type) and the current heatsink temperature in degrees centigrade.



## 5.4.1 TOOLBAR

ICON	DESCRIPTION	SHOTRCUT
	<b>DOWNLOAD</b> Download of parameter file from disk to L180	CTRL+R
	<b>UPLOAD</b> Store parameters from L180 onto disk	CTRL+S
	<b>PARAMETER LIST</b> Access to the entire parameter list only possible in privileged mode (password required)	CTRL+P
	<b>SAVE</b> Save parameters into drive	F2
	<b>RESET</b> Software drive reset	SHIFT+F7
	<b>SCOPE</b> Scope function	CTRL+O
	<b>UPGRADE</b> Firmware upgrade with compare function	CTRL+M
	<b>ALARM, STATUS</b> One click activates the alarm window, two clicks activates the status window	CTRL+A only Alarm Window
	<b>AUTOMATIC COMMAND MODE</b> Automatic command mode, firmware A1 only accessible in privileged mode (password required), firmware A2 with L180GUI 2.0 no password required.	
	<b>PARAMETER SETTING</b> Access to all customer accessible parameters	CTRL+L
	<b>HELP</b> Description of the GUI features	F1
	<b>DRIVE ENABLE</b> Software enable if hardware enable is present	
	<b>DRIVE DISABLE</b> Software disable	

### 5.4.2 QUICK START

The following section describes a quick start method for the MOOG L180 servo drive. This allows a quick and easy set up of the L180 motor drive system and permits motor operation. It is recommended to be familiar with the local safety regulations, the installation routine and the warning notes of the manual.

If the drive is correctly installed according to the installation section, the L180GUI completes the drive set up and allows adjustment of all application related parameters. The L180GUI comes with parameter files for each MOOG motor. Thus a minimum amount of parameters must be set. The major steps are as follows:

1. **Disable the drive.**
2. **Check serial communication, if necessary.** The serial link configuration is available in the *CONFIGURATION* menu (see section 5.4.4).
3. **Download of the appropriate parameter file with the *DOWNLOAD* button** (see section 5.4.5).
4. **To set application specific parameters, use the *PARAMETER SETTING* button** (see section 5.4.6). Drive tuning for your specific application required.

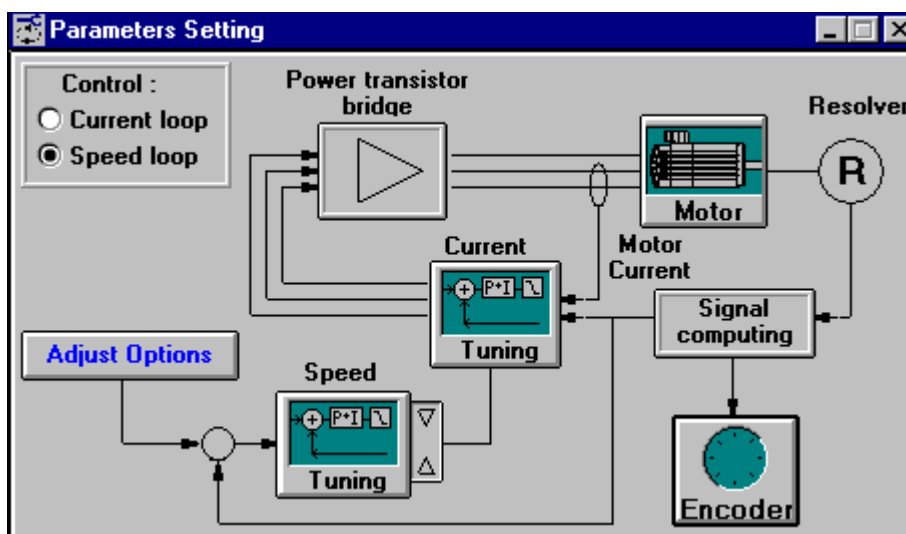

Figure 49: Parameters Setting

In the **ADJUST OPTIONS** box, pay particular attention to the end switch (P24), digital/analog (P27) and external I-limit (P10) parameters. Motor, current and speed loop parameters are preconfigured and should meet with a wide range of applications.

5. **Save all parameters into the drive, using the *SAVE* button.**
6. **To save this new application specific file to disk use the *UPLOAD* button** (see section 5.4.7). Make sure to use a new file name to avoid confusion with the standard parameter files.
7. **Enable the drive**

The motor drive system will operate using the analog command input.

### 5.4.3 GENERAL INSTRUCTIONS

The parameters of the L180 servo drive are divided into two groups. Some parameters will become valid by pressing **ENTER**, others only by clicking the **SAVE** button. The parameters are marked with **SAVE** and **ENTER** in the appropriate table.

The L180GUI version 2.0 offers an appropriate feature to identify the save or enter status of the parameter. The **SAVE** button is blinking if any parameter change is made and two different warnings occur. If parameters marked for **ENTER** are changed, the warning in Figure 50 appears every time. If parameters marked for **SAVE** are changed, the warning in Figure 51 appears once.



Figure 50: Warning for ENTER parameters



Figure 51: Warning for SAVE parameters

The parameters are also divided into two groups regarding read and write ability. The appropriate table will highlight the status of the parameter with **r/w** for read and write parameters and **r** for read only parameters.



#### WARNING

Because of safety issues, **SAVE** will only operate when the drive is disabled. Different parameter settings can cause uncontrolled behavior of the servomotor which could lead to mechanical damage or personnel injury.

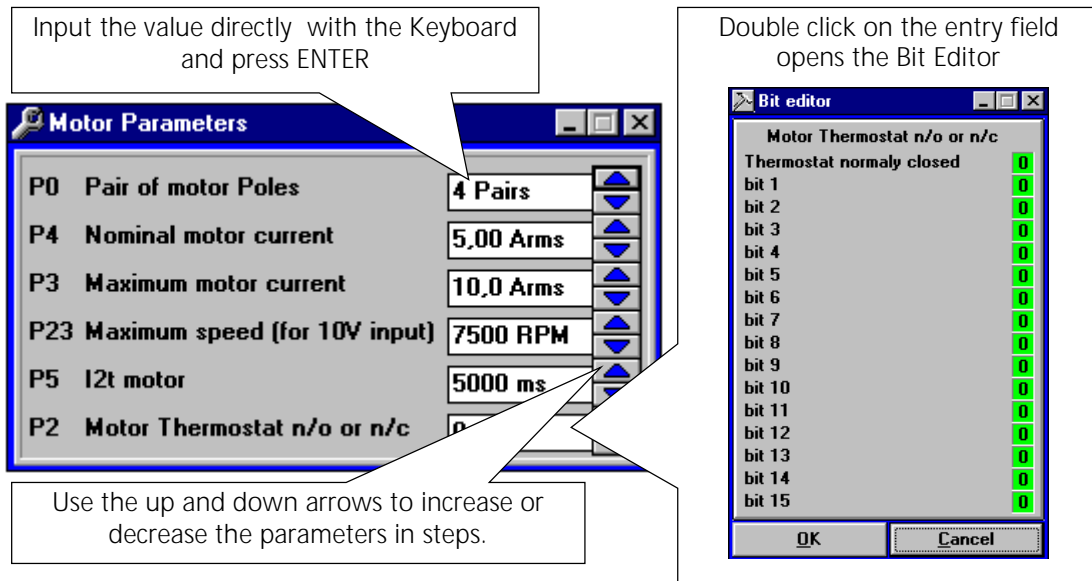

Figure 52: GUI dialog box features

Additional information is included in the help file, it can be accessed either by clicking on the **HELP** button or the **HELP** menu. To obtain help on the active dialog box press key **F1**.

#### 5.4.4 SERIAL LINK

The L180GUI uses the serial port of a PC to communicate with the L180 servo drive, using the RS232 serial standards. The L180GUI software and the physical link between the PC and the L180 servo drive must be configured correctly. The configuration of the serial link can be done by selecting the **SERIAL LINK** menu item in the **CONFIGURATION** menu.

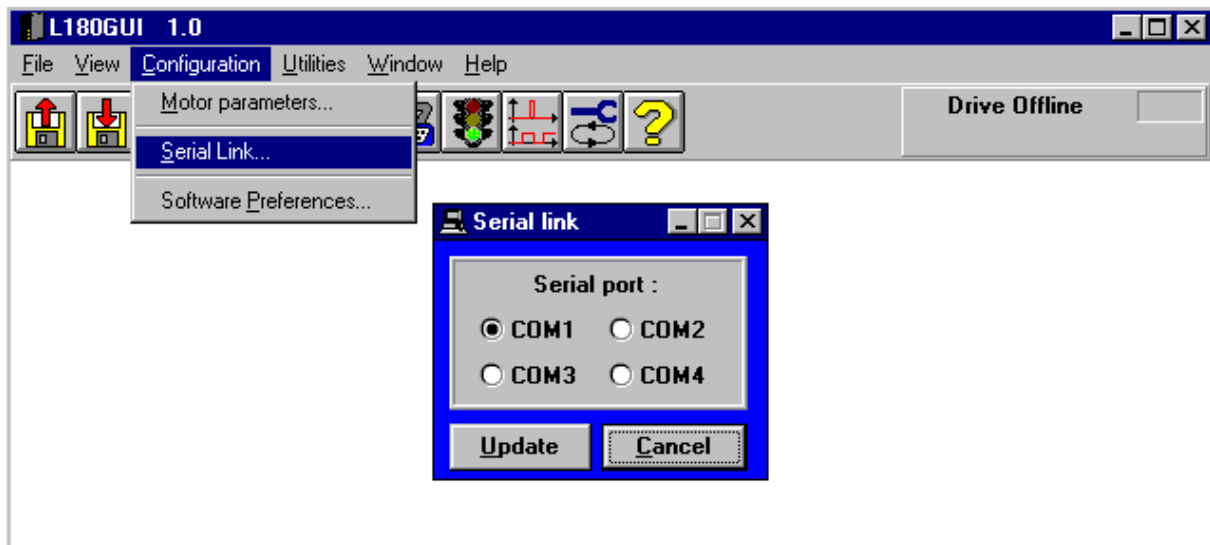

Figure 53: Setting Serial Port

If the serial port configuration is correct, the communication will be established automatically when the PC and the L180 servo drive are physically connected. If the L180 servo drive is offline, an indication will appear in the upper right corner. If communication is established, the drive size, firmware version, motor type and the heat sink temperature will be displayed. All other configuration of the serial port is fixed.

#### 5.4.5 PARAMETER FILE DOWNLOAD

Parameters can be downloaded by using the toolbar button or with the **DOWNLOAD** item in the **FILE** menu. The drive must be disabled to download a parameter file. The window illustrated in Figure 54 opens and allows a parameter file search. The parameter files are organized in three different directories which relate to the three different servo drive sizes.

The L180GUI 2.0 is delivered with a new set of motor parameters for appropriate setting of additional parameters. These can be found in the folder **PAR\_A2**.

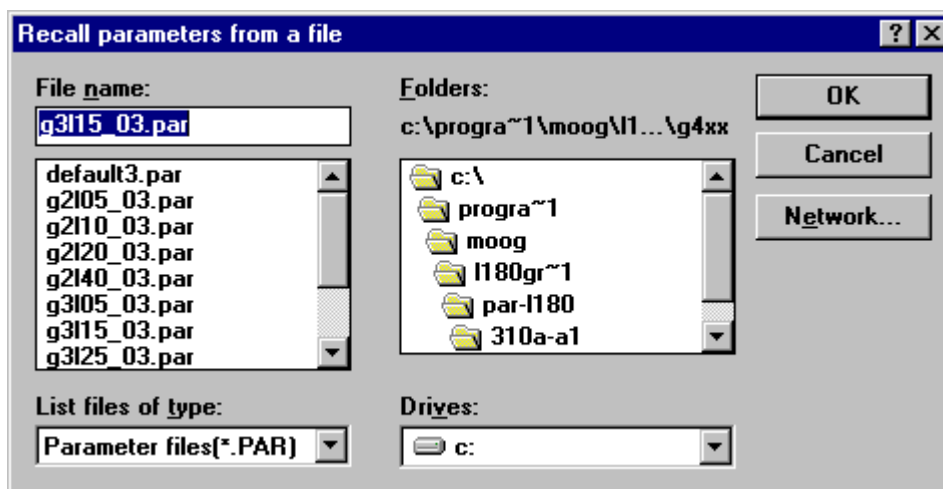

Figure 54: Parameter Download

The default files (e.g. default3.par) are factory settings and can be recovered, if necessary.



#### WARNING

Parameter files are motor **AND** drive specific; separate files have to be used for each motor/drive combination. In the file name G4L20\_04.PAR there exists the motor type G4L20 (found on the motor nameplate) and the drive size 04 which represents an L180-410x-xx (found on the drive nameplate).

#### 5.4.6 PARAMETER SETTING

Parameter setting can be done by clicking on the **PARAMETERS SETTING** button or on the **PARAMETERS SETTING** item in the **UTILITIES** menu. The shortcut for this function is **CTRL+L**. The **PARAMETERS SETTING** window opens and application specific parameters can be adjusted. These must then be saved into the drive.

#### Current loop

Motor current/torque is regulated. The speed of the motor in current (torque) mode is monitored. If the motor speed is 20% above the maximum motor speed an over speed alarm will occur. The over speed failure is permanently latched and results in a coast stop of the motor.

#### Speed loop

Motor speed is regulated. The speed control closure around the current loop. Proper tuning for your specific application is required.

### 5.4.6.1 ADJUST OPTIONS

The **ADJUST OPTIONS** dialog box is only available by clicking on the **ADJUST OPTIONS** button in the **PARAMETERS SETTING** window.

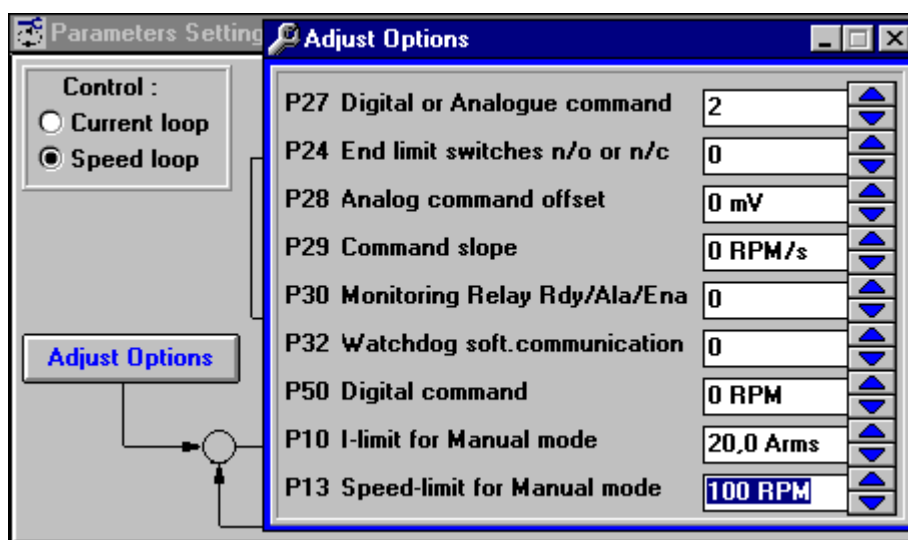

Figure 55: Setting Adjust Options

Table 30: Adjust Options

Address	Save	R / W	Unit	Range	Description
27	ENTER	r,w	-	0,1	Selection of analog command = 1 or digital command = 0
24	SAVE	r,w	-	0...3	Configuration of the end switches, 0 = both are normally open, 3 = both are normally closed
28	ENTER	r,w	mV	-197...197	Programmable ANALOG IN offset
29	ENTER	r,w	rpm/s A/s	0...1769418 0...3394	Programmable ramp of the analog input in speed mode Programmable ramp of the analog input in current mode
30	SAVE	r,w	-	0...2	Programmable monitoring relay
32	ENTER	r,w	ms	0...32767	Programmable time of the serial communication watchdog
50	ENTER	r,w	rpm Apeak	-7578...7577 $\pm I_{max}, drive$	Digital command if drive is in digital and speed mode Digital command if drive is in digital and current mode
10	ENTER	r,w	Arms	0... $I_{max}, drive$	Limitation of the motor current, if selected
13	ENTER	r,w	rpm	0...FFFFh	Limitation of the motor speed, if selected

The parameter 13 is only accessible with L180GUI 2.0 and firmware A2. If the A1 firmware is in use the parameter has no meaning and is inaccessible.

### Digital or Analog Command

J3:2 ANALOG IN -	0 = Digital Command	1 = Analog Command
J3:3 ANALOG IN +	The default value is Analog Command (1).	
	Digital command :	
	Digital command (parameter 50) is read to set the command value.	
	Analog command :	
	Input voltage ANALOG IN is converted to set the command value.	

### Endswitch

J3:19 END-SW1	End switches 1 and 2 can be configured normally open or normally closed. End switch 1 affects the clockwise rotation, end switch 2 affects the counterclockwise rotation when viewed from the shaft side. The default value is end switches 1 and 2 normally closed (3).
J3:20 END-SW2	
GND	

Table 31: End-switch Configuration

		0	1	2	3
end switch 1	n.o.	×		×	
	n.c.		×		×
end switch 2	n.o.	×	×		
	n.c.			×	×

If a end switch is activated when the L180 is in speed mode, the motor is brought to a stop by the servo drive, and further movement in the direction of that end switch is not allowed. If no ramp is programmed the stop will be the maximum system deceleration possible, otherwise the motor ramps down as adjusted.

If the end switch is activated when the L180 is in current mode, then the torque command will be clamped to zero in that direction. If no ramp is programmed the current will be clamped in one step to zero, otherwise the current ramps down as adjusted.

Torque and speed command in the other direction is still possible.

### Analog Command Offset

When analog command is selected, the input offset voltage can be adjusted with this parameter. The default value is zero (0).



**Command Slope**

Command ramp generator, when this parameter is zero, no ramp is performed. When a value different of zero is programmed, the command edges are limited (for digital and for analog command). The default value is zero (0).

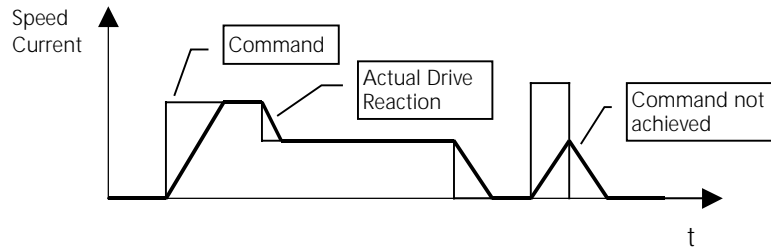

Figure 56: Command Slope



**WARNING**

The command slope also affects the functionality of the end switches. If a ramp is programmed, the speed or current will ramp down when an end switch is activated. This functionality must be reviewed with your application.

**Monitoring Relay**

J3:8 ALARM  
J3:10 ALARM COM

This parameter adjusts the functionality of the monitoring relay. The default value is zero (0). Please consult section 6.2.5 for detailed information.

Table 32: Monitoring Relay Configuration

Status	Value	Description
System Ready	0	The relay contact will be closed after the power up procedure and it will open if the drive faults
Alarm	1	The relay contact will be closed only when a fault occurs
Enabled	2	The relay contact will be closed when the drive is enabled

**Watchdog Software Communication**

Watchdog for the serial link. If the drive does not receive any serial data within the defined time (in ms), software watchdog alarm is set. If the value is zero (0) watchdog is disabled. The default value is zero (0).

**Digital Command (Speed or Current)**

When the drive is set into digital mode this value defines the command value. The digital command is sent to the drive via the serial link.

#### External I-Limit, I-limit for Manual mode, Speed limit in Manual mode

J3:7 AUTO/MANUAL	<p>The L180 provides a reduced power mode for possible user safety requirements. This mode is called MANUAL mode. When the AUTO/MANUAL digital input is disconnected the drive is in MANUAL mode; when connected to GND the drive is in AUTO mode.</p>
GND	<p>The firmware A1 (C08500-001) provides current limitation only (no speed limitation) in both speed and current loops. The parameter 10 defines the maximum current provided of the drive in MANUAL mode. The default value is 10% of the maximum motor current.</p> <p>The firmware version A2 (C08500-002) together with L180GUI version 2.0 provides speed and current limitation in speed and current mode. In current mode the drive will be disabled and display over speed warning b if the motor speed is 20% above the manual speed limit. In speed mode the drive will regulate the motor speed and not exceed the manual speed limit. The parameter 13 defines the maximum speed provided of the drive in MANUAL mode. The default values are 10% of the maximum motor current or speed. The MANUAL mode limits have no influence on the analog input scaling. These values can be set to the maximum drive current or speed if not required, thus wiring of the digital input becomes unnecessary. In AUTO mode the drive provides the maximum motor current and speed.</p>

#### 5.4.6.2 ENCODER SIMULATION CONFIGURATION

The Encoder Simulation generates incremental encoder formatted output signals developed from a resolver position transducer.

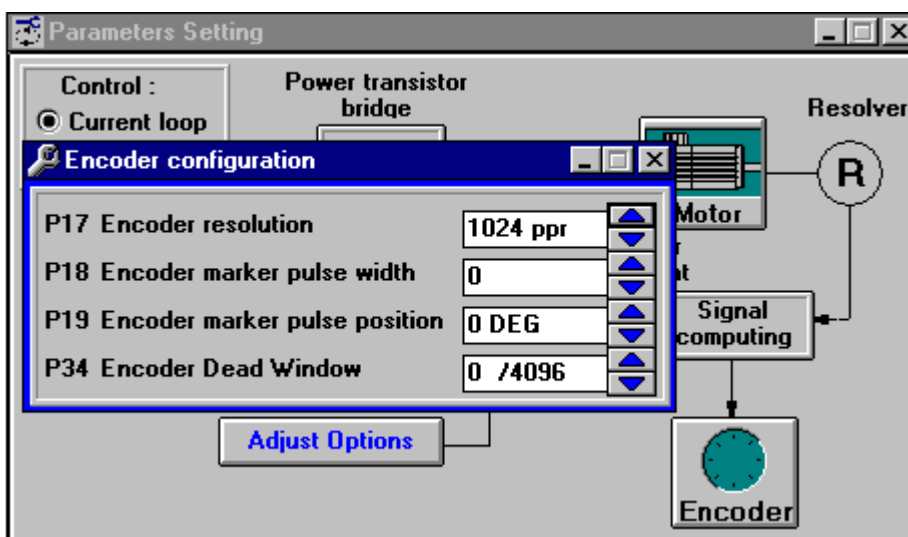

Figure 57: Encoder Simulation Configuration

Table 33: Encoder Configuration

Address	Save	R / W	Unit	Range	Description
17	SAVE	r,w	ppr	1...1024 (2048)	Encoder resolution in pulses per revolution
18	SAVE	r,w	-	0...6	Configuration of the zero marker channel and width
19	ENTER	r,w	deg (°)	-180...180	Configuration of the zero marker position
34	ENTER	r,w	-	0...256	Encoder dead window

### Encoder Resolution

J4:8	A	The line count of the encoder signals is programmable up to 2048 pulses per revolution (ppr). This is 8192 in quadrature. An extrapolated mode is used from 1025ppr to 2048ppr. A resolution up to 2048 is available up to 6000rpm. At programmed speeds above 6000rpm only 1024ppr accepted. The default value is 1024 ppr.
J4:9	$\bar{A}$	
J4:10	B	
J4:11	$\bar{B}$	

### Encoder Marker Pulse Width

J4:6	$\bar{Z}$	Configuration of the encoder zero marker channel and width. The default value is zero (0).
J4:7	Z	

Table 34: Encoder Marker Configuration

Value	Description	Gated
0	¼ period of Encoder output channel A	A
1	½ period of Encoder output channel A	A
2	1 period of Encoder output channel A	A
4	¼ period of Encoder output channel A	B
5	½ period of Encoder output channel A	B
6	1 period of Encoder output channel A	B

### Encoder Marker Pulse Position

Defines the offset of the zero marker on the encoder simulation output, with respect to the motor's resolver zero position, in mechanical motor shaft degrees. The resolution of the  $\pm 180^\circ$  angle is 15 bit (32767). The default value is zero (0).

### Encoder Dead Window

The encoder simulation may oscillate approx.  $\pm 1$  increment because of the motor position jitter. This oscillation can be stabilized with the encoder dead window. Encoder signals will only be simulated if the resolver position changes more than the adjusted value, with respect to the resolver demodulation which is 12 bit (4096). This feature provides steady encoder simulation at standstill of the motor. The position error is not cumulative. The position precision is also reduced and the time delay increases with the width of the dead window. A value of zero disables this function. The default value is zero(0).

Example of the encoder output signals, with encoder marker pulse width of 5 and the encoder marker pulse position of 0. The motor is turning clockwise when viewed from the shaft side.

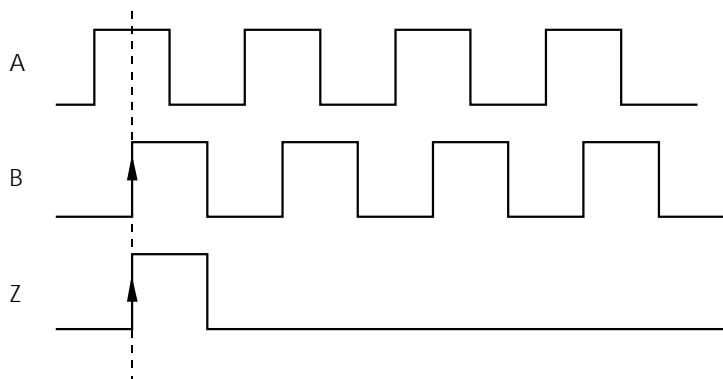

Figure 58: Encoder Signals

### 5.4.6.3 SPEED LOOP TUNING

The **SPEED TUNING** button in the parameter setting window calls up the **ADJUST SPEED LOOP PARAMETERS** dialog box.

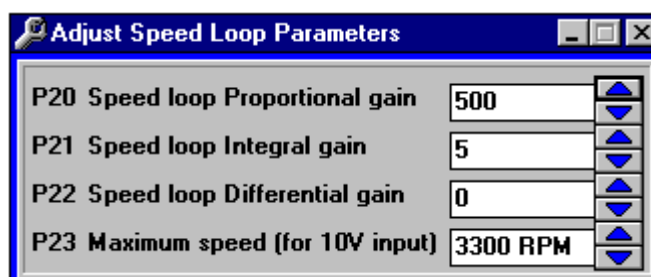

Figure 59: Adjust Speed Loop Parameters

The motor parameter files are supplied with proportional and integral gains. These preconfigured parameters should be reviewed for your particular application.

Table 35: Speed Loop Configuration

Address	Save	R / W	Unit	Range	Description
20	ENTER	r,w	As/rad	1...32767	Speed loop proportional gain
21	ENTER	r,w	A/rad	0...250	Speed loop Integral gain
22	ENTER	r,w	A/rad s	0...32767	Speed loop differential gain
23	SAVE	r,w	rpm/10V	0...32767	Velocity scaling of the analog input at 10V

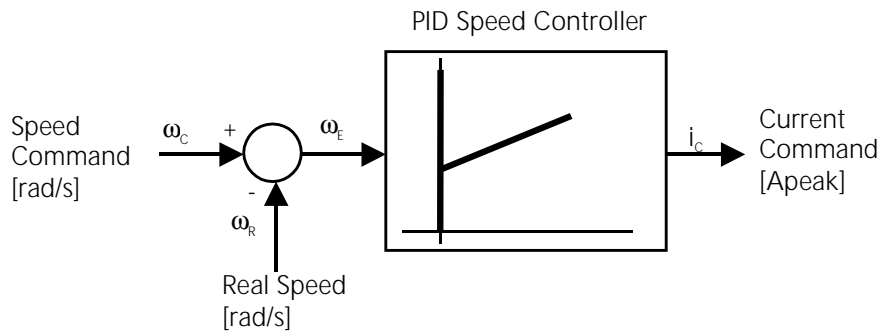

Figure 60: Speed Loop Regulator

$$i_C = K_p \cdot \omega_E(n) + K_i \cdot \sum_{i=0}^n (\omega_E(i) \cdot \Delta T) + K_d \frac{\{\omega_E(n) - \omega_E(n-1)\}}{\Delta T}$$

- $\omega_E(n)$ : present sample
- $\omega_E(n-1)$ : sample one sampling period before
- $\Delta T$ : Sampling time

### Speed Loop Proportional Gain

The proportional gain is without any unit and represents the internal number in decimal format. The actual P-gain can be calculated with the following expression:

$$K_p = 4,92 \cdot 10^{-6} \cdot I_{max,drive} \cdot P_{Speed} [A_{peak} s / rad]$$

$P_{Speed}$  = Speed Loop Proportional Gain

### Speed Loop Integral Gain

The integral gain is without any unit and represents the internal number in decimal format. The actual I-gain can be calculated with the following expression:

$$K_i = 3,73 \cdot 10^{-2} \cdot I_{max,drive} \cdot I_{Speed} [A_{peak} / rad]$$

$I_{Speed}$  = Speed Loop Integral Gain

The actual integral time can be calculated with the following expression:

$$T_i = \frac{K_p}{K_i}$$

Thus the I-gain adjustment is inversely proportional to the integral time, an increasing I-gain means a decreasing integral time.

#### Speed Loop Differential Gain

The differential gain is without any unit and represents the internal number in decimal format. The default value is zero (0). The actual D-gain can be calculated with the following expression:

$$K_p = 6,5 \cdot 10^{-10} \cdot I_{max,drive} \cdot D_{Speed} [A_{peak} / (rad \cdot s)]$$

$D_{Speed}$  = Speed Loop Differential Gain

#### Maximum Speed (for 10V input)

J3:2 ANALOG IN -

J3:3 ANALOG IN +

This parameter sets the analog input scaling of the drive. The default value is the theoretical maximum speed of the motor when being driven by the L180. The parameter can be set to any lower value. The over speed alarm is activated when the instantaneous motor speed value is 20% above the maximum speed value.



#### WARNING

Servomotors can accelerate highly dynamically. They also have enormous torque. The following points must therefore be observed when starting the system.

- **The danger zone around the motor must be cordoned off.**

The system must feature a safety guard to prevent personnel from reaching into or entering the danger zone. If the safety system is tripped, the drive system must be disconnected from the main voltage immediately.

- **The control parameters determine the dynamic and static behavior of the servomotor.**

Incorrectly set parameters can cause the servomotor to run at an excessive speed (instable controller settings).

- **Mechanical Damage could occur.**

Ensure that the application allows the use of this speed and torque amplitude and length of travel, (period, duty cycle), without damage to the machine before proceeding with the tuning procedure. If the mechanical part of the application is not designed for a step response with full motor torque, the procedure described hereafter could cause mechanical damage.

The speed loop adjustment procedure is a step response which is monitored with the built-in scope function. The following procedure is recommended:

**1. Disable the drive.**

**2. Set drive into Analog Mode, if necessary.**

**3. Speed Loop.**

Set servo drive into speed mode, default mode.

**4. Speed tuning.**

Click on the Speed tuning button and set integral and differential gain to 0 and proportional gain to 500.

**5. Scope (see section 5.4.9 Scope).**

Click on the **SCOPE** button and select:

- for Channel 1 instant speed (P 68)
- for Channel 2 instant current (P 67)
- The time scaling depends on the application, but a default value of 16ms/div meets a wide range of applications.
- The vertical scaling depends on the speed amplitude.
- Select a trigger value for the instantaneous speed and click on **CONTINUOUS** recording.

**6. Function Generator.**

The use of an external function generator on the analog input is recommended with the firmware A1 (C08500-001). If you would like to use the built-in **AUTOMATIC COMMAND MODE** (Function generator), please get in contact with your local application engineer.

The firmware A2 (C08500-002) together with the L180GUI version 2.0 provides a properly operating built-in function generator for the optimization procedure.

The function generator should produce a single-shot square wave step whose duration is greater than the system acceleration time to the application speed but within the mechanical constraints of the application itself. The amplitude of the speed step can be adjusted by the scaling factor in the adjust speed loop parameters screen. If the current is in saturation during the acceleration period the speed amplitude should be reduced.

**7. Enable.**

Enable the drive and switch the function generator on. The motor will run according to the analog input.

### 8. Optimize the Speed Loop Proportional Gain (P20).

A typical start value is 500. A step response looks as follows:

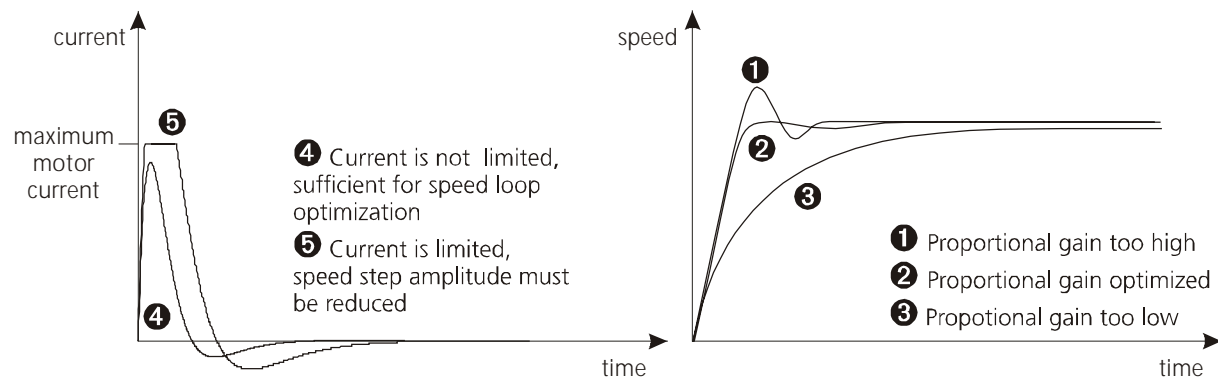

Figure 61: Speed Step, proportional gain

### 9. Optimize the Speed Loop Integral Gain (P21).

A typical start value is 10. A step response looks as follows:

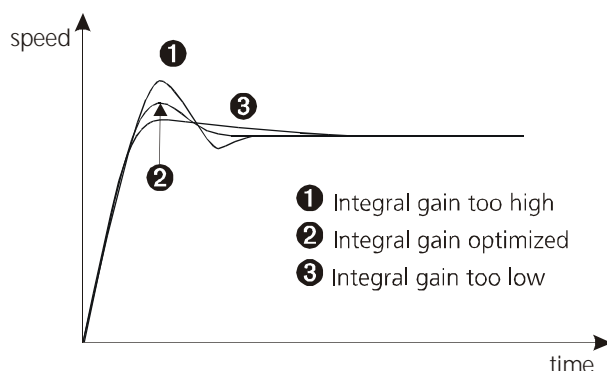

Figure 62: Speed Step, integral gain

10. The speed loop differential gain (P22) remains at zero (0) in most applications.

11. Disable Drive.

12. Save all parameters into the drive, using the *SAVE* button.

13. To save this new application specific file to disk use the *UPLOAD* button (see section 5.4.8). Make sure to use a new file name to avoid confusion with the standard parameter files.



**5.4.6.4 CURRENT LOOP TUNING**

There should be no need to adjust the current tuning parameters given the appropriate file for the motor/drive combination has been selected.



**WARNING**

Improper current loop adjustment can cause motor instability. The servo motor will act in an uncontrolled manner and mechanical damage can occur. The current loop parameters are preconfigured and only influenced by the electrical model of the motor. If you feel the necessity to change the current loop parameters please get in contact with your local application engineer.

The **CURRENT TUNING** button in the parameter setting window calls up the **ADJUST CURRENT LOOP PARAMETERS** dialog box.

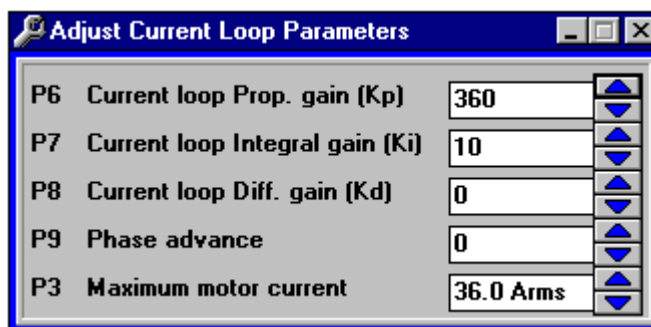

Figure 63: Adjust Current Loop Parameters

Table 36: Current Loop Configuration

Address	Save	R / W	Unit	Range	Description
6	ENTER	r,w	V/A	1...1000	Current loop proportional gain
7	ENTER	r,w	V/As	0...100	Current loop integral gain
8	ENTER	r,w	Vs/A	0...32767	Current loop differential gain
3	SAVE	r,w	Arms	0...32767	Maximum motor current

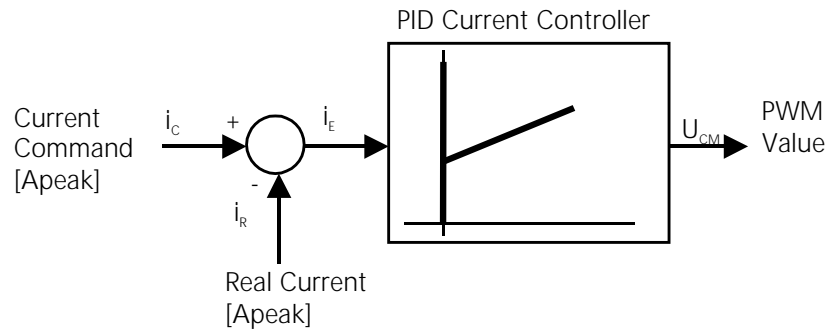

Figure 64: Current Loop Regulator

$$U_{CM} = K_p \cdot i_E(n) + K_i \cdot \sum_{i=0}^n (i_E(i) \cdot \Delta T) + K_d \frac{\{i_E(n) - i_E(n-1)\}}{\Delta T}$$

- $i_E(n)$ : present sample  
 $i_E(n-1)$ : sample one sampling period before  
 $\Delta T$ : Sampling time

### Current Loop Proportional Gain

The proportional gain is without any unit and represents the internal number in decimal format. The actual P-gain can be calculated with the following expression:

$$K_p = \frac{P_{Current}}{I_{max,drive}} [V / A_{peak}]$$

$P_{Current}$  = Current Loop Proportional Gain

### Current Loop Integral Gain

The integral gain is without any unit and represents the internal number in decimal format. The actual I-gain can be calculated with the following expression:

$$K_i = \frac{7500 \cdot I_{Current}}{I_{max,drive}} [V / A_{peak} s]$$

$I_{Current}$  = Current Loop Integral Gain

The actual Integral time can be calculated with the following expression:

$$T_i = \frac{K_p}{K_i}$$

Thus the I-gain adjustment is inversely proportional to the integral time, an increasing I-gain means a decreasing Integral time.

### Current Loop Differential Gain

The differential gain is without any unit and represents the internal number in decimal format. The default value is zero (0). The actual D-gain can be calculated with the following expression:

$$K_d = \frac{133 \cdot 10^{-6} \cdot D_{Current}}{I_{max,drive}} [Vs / A_{peak}]$$

$D_{Current}$  = Current Loop Differential Gain

### Maximum Motor Current

This parameter defines the maximum current to the servomotor, and is supplied with each motor parameter file. The default value is the maximum motor current value on the servomotor nameplate or the maximum current the L180 can deliver. If motor torque should be reduced in general, this parameter should be decreased. In general no adjustments are necessary.

#### 5.4.6.5 MOTOR PARAMETERS

There should be no need to adjust the motor parameters given the appropriate file for the motor/drive combination has been selected.



#### WARNING

Improper motor parameter adjustment can cause motor instability or damage. The servo motor will act in an uncontrolled manner and mechanical damage can occur. The parameters are preconfigured and only influenced by the electrical model of the motor. If you feel the necessity to change these parameters please get in contact with your local application engineer.

The **MOTOR** button in the parameter setting window calls up the **MOTOR PARAMETERS** dialog box.

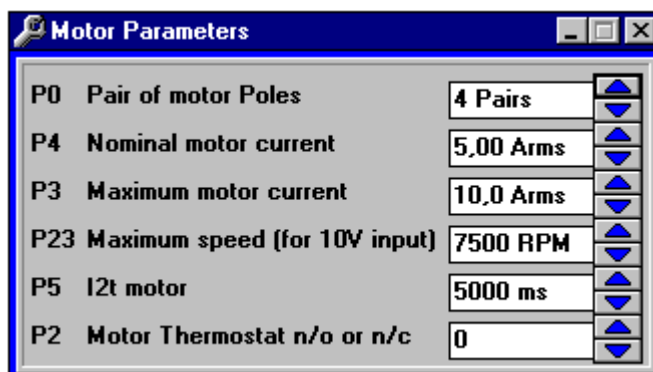

Figure 65: Motor Parameters

Table 37: Motor Configuration

Address	Save	R / W	Unit	Range	Description
0	ENTER	r,w	-	1...6	Pair of motor poles, MOOG motors are 8 and 12 pole motors, thus 4 and 6 pole pairs.
4	ENTER	r,w	Arms	0...16383	Nominal motor current is the continuous stall current of the motor
3	ENTER	r,w	Arms	0...32767	Maximum motor current
23	Save	r,w	rpm/10V	-12973...12973	Velocity scaling of the analog input for 10V
5	Save	r,w	ms	0...10000	Time of I <sup>2</sup> t motor protection
2	Save	r,w	-	0,1	Motor thermostat n.o or n.c

### Pair of Motor Poles

This parameter defines the number of motor pole pairs, and is supplied with each motor parameter file. No adjustments are necessary.

### Nominal Motor Current

This parameter defines the nominal current to the servomotor, and is supplied with each motor parameter file. The default value is the nominal motor current value on the servomotor nameplate or the nominal current the L180 can deliver. This parameter influences the I<sup>2</sup>t protection of the motor. No adjustments are necessary.

### Maximum Motor Current

This parameter defines the maximum current to the servomotor, and is supplied with each Motor parameter file. The default value is the maximum motor current value on the servomotor nameplate or the maximum current the L180 can deliver. If motor torque should be reduced in general, this parameter should be decreased. Typically no adjustments are necessary.

### Maximum Speed (for 10V input)

J3:2 ANALOG IN –	This parameter sets the analog input scaling of the drive. The default value is the theoretical maximum speed of the motor when being driven by the L180. The parameter can be set to any lower value. The over speed alarm is activated when the instantaneous motor speed value is 20% above the maximum speed value.
J3:3 ANALOG IN +	

### I<sup>2</sup>t Motor

	<p>This parameter defines the calculation time of the I<sup>2</sup>t protection, and is supplied with each motor parameter file. The parameter is set to values which avoid damage to the servomotor or servo drive.</p> <p>The I<sup>2</sup>t threshold is calculated by the nominal motor current. The calculation time influences the calculation of the instantaneous I<sup>2</sup>t value. The instantaneous I<sup>2</sup>t value will be set to zero only by the software reset of the drive. Hardware enable will not set the instantaneous I<sup>2</sup>t value to zero.</p> <p>When the I<sup>2</sup>t limit is achieved and the I<sup>2</sup>t alarm is not latched the drive will display warning 2 and the motor current is limited to the nominal motor current. This is the default setting.</p> <p>When the I<sup>2</sup>t threshold is achieved and the I<sup>2</sup>t alarm is latched the drive will be disabled and the alarm 2 is displayed.</p> <p>In general no adjustments are necessary.</p>
--	--

### Motor Thermostat n/o or n/c

	<p>This parameter defines the type of thermal switch included in the servomotor, and is supplied with each Motor parameter file. A normally open contact can be set with zero (0) and a normally closed contact can be set with one (1). The default value is zero (0). The motor is supplied with a thermistor of type NTC 220 k<math>\Omega</math> at 25 degrees C. The drive identifies only if the resistor value is above or below 4.2 k<math>\Omega</math>. No adjustments are necessary.</p>
--	---

### 5.4.7 AUTOMATIC COMMAND MODE (FUNCTION GENERATOR)

The firmware A2 together with L180GUI version 2.0 provides a built-in function generator for drive commissioning and system tuning. If **COMMAND MODE** is chosen in the **UTILITY** menu a warning window appears. If **YES** is chosen the drive is prepared for the **AUTOMATIC COMMAND MODE**, if **NO** is chosen the drive operates according to the analog input.

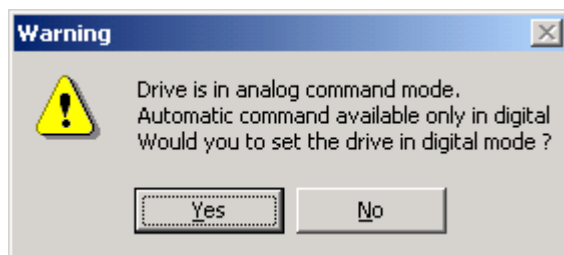

Figure 66: Warning during automatic command mode start-up

The window in Figure 67 appears if the choice is made on the warning window, doesn't matter what was chosen.

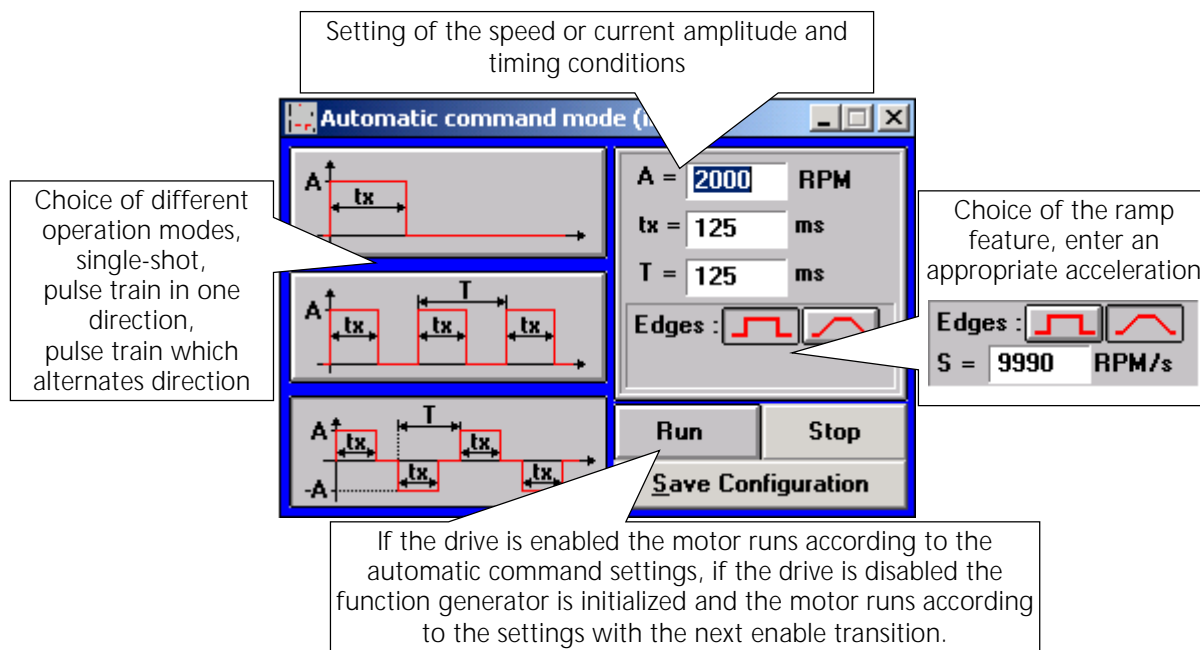

Figure 67: Automatic command mode

If the automatic command mode is quit and the drive was in analog mode previously the window in Figure 68 prompts to reset the drive in analog mode.

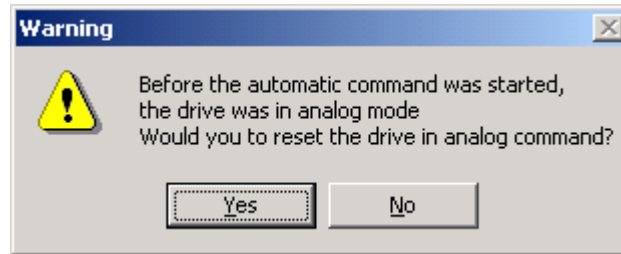

Figure 68: Warning after quit of the automatic command mode



### WARNING

If the drive is reset in analog mode and an analog command is applied, the warning in Figure 69 appears. The window appears if the analog command is higher than  $\pm 80$  mV.

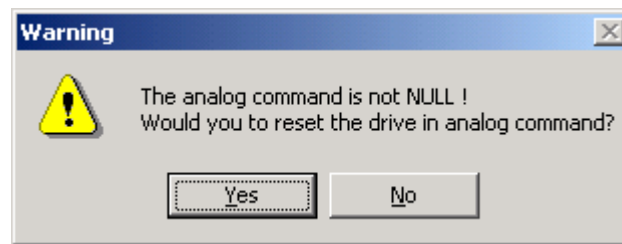

Figure 69: Warning analog command applied

If yes is chosen the motor accelerates and runs according to the analog command.

#### 5.4.8 UPLOAD OF PARAMETER FILES

The parameter file can be saved to disk with the **UPLOAD** button or the menu item in the **FILE** menu. Create an appropriate file and folder if necessary.

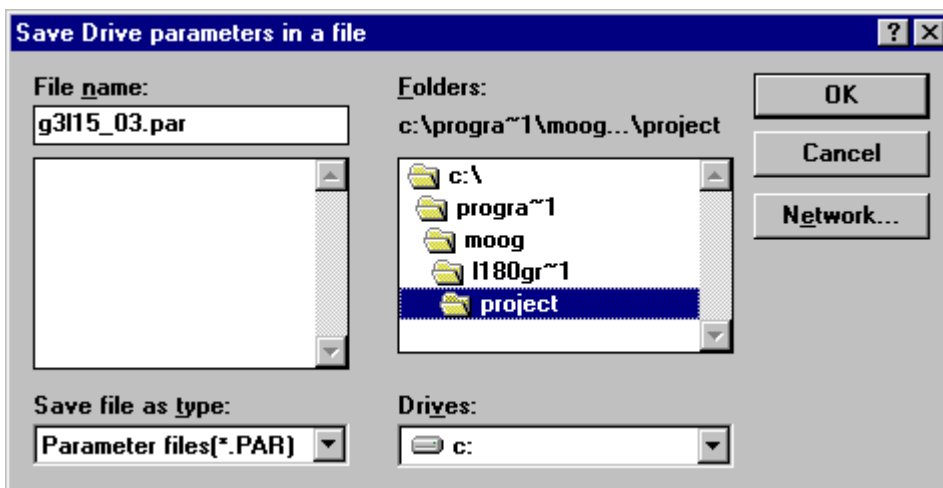

Figure 70: Parameter Upload



#### WARNING

MOOG standard parameter files are read only files and should not be overwritten. It is recommended to save your modified parameter set into a file that has an application specific name.

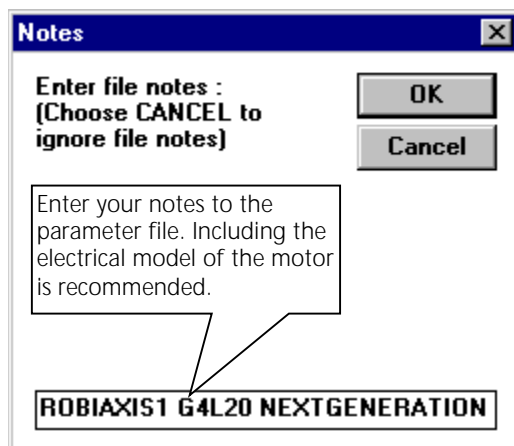

Figure 71: Notes of parameter files



#### 5.4.9 SCOPE

The scope measures 80 values per channel for its display and will only update after a complete measurement. Be cautious of unrealistic scaling on measurement channels as this may lead to erroneous scope traces. A large time scale will cause a greater delay in the scope update.

The scope is a convenient tool and operates like a common two channel oscilloscope with similar features. These features include trigger level and position setting, time scaling, channel selection and vertical scaling with additional measurement by setting cursor location. Operation is possible in single shot or continuous run mode. The sampled traces can be stored and recalled for comparison of different control loop adjustments. The print feature is a useful tool for permanent documentation of drive performance.

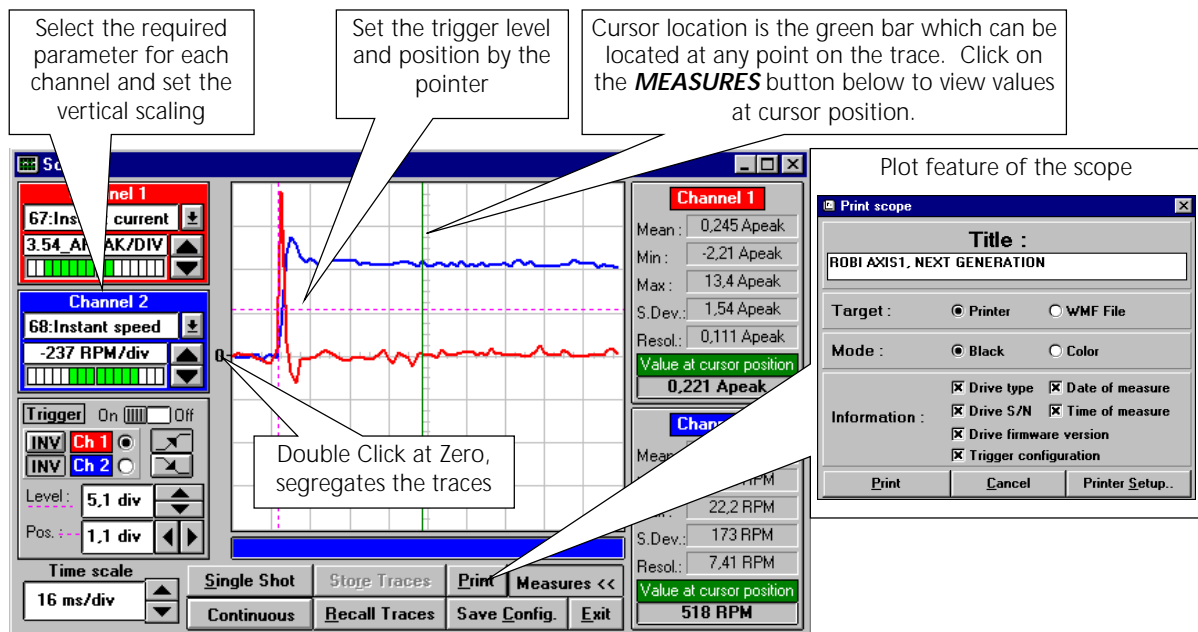

Figure 72: Scope

### 5.4.10 FIRMWARE UPGRADE



#### WARNING

A Firmware Upgrade is only necessary on demand.

If necessary, a firmware upgrade can be performed either by clicking on the toolbar button or by selecting the menu item **UPGRADE OF PROGRAMS** in the **UTILITIES** menu. The procedure is described in the Figure 73 below. A firmware upgrade will not change parameter settings, but could change their meanings due to the introduction of new functionality.

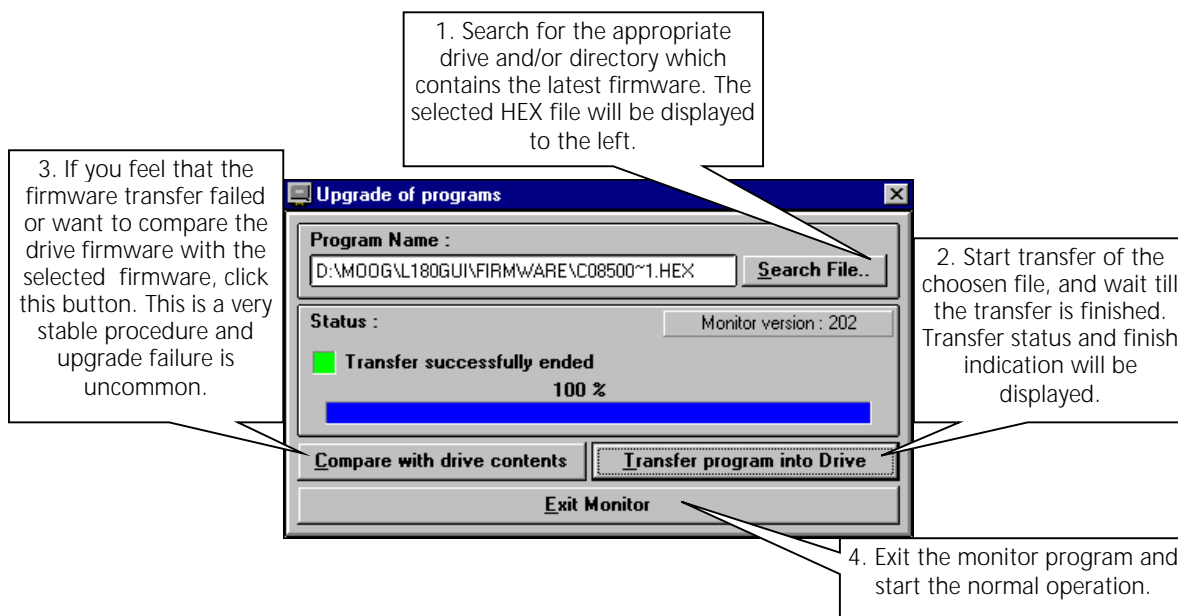

Figure 73: Firmware Upgrade

## 5.4.11 EDIT PARAMETER FILE

The parameter file edit feature is accessible in the **FILE** menu.

**WARNING**

Use the edit feature only for entry of additional notes or information. The parameter values represent the internal values of the servo drive without any unit. Arbitrary adjustments may lead to an uncontrolled servomotor with the potential of mechanical damage and personal injury.

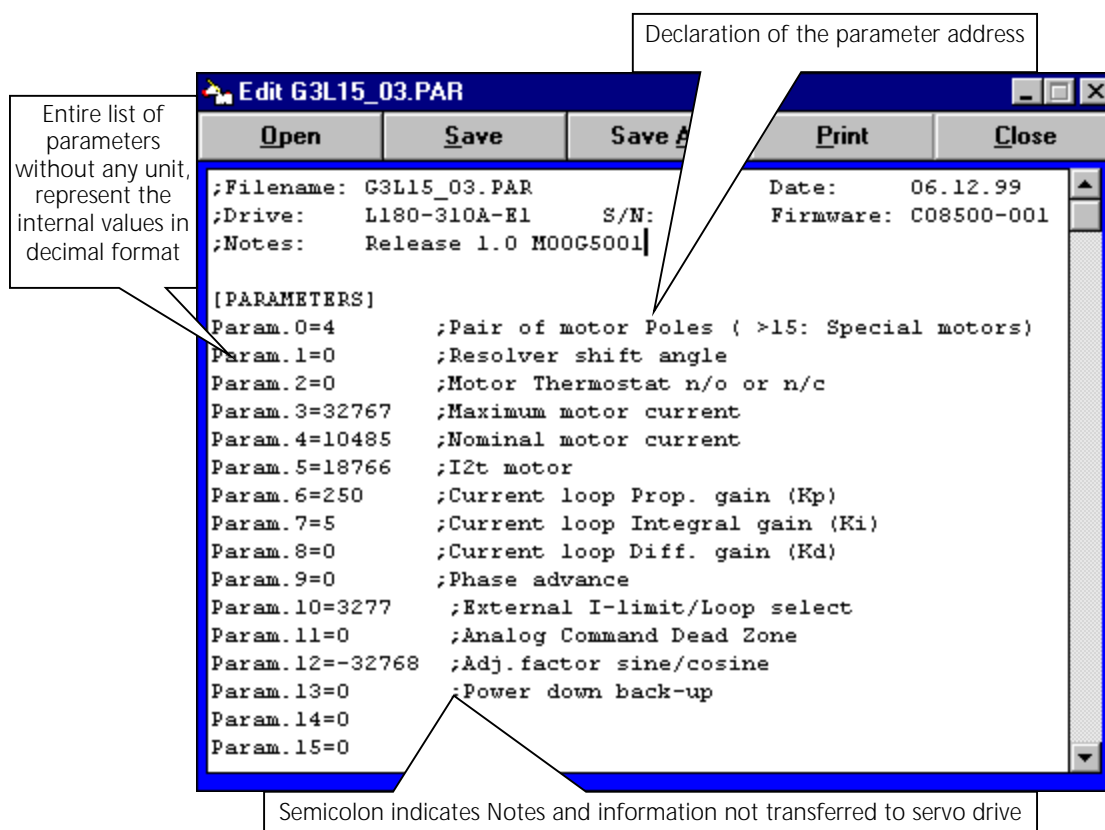

Figure 74: Parameter File Editor

### 5.4.12 PRIVILEGED ACCESS

For drives with firmware A1 (C08500-001) the **PRIVILEGED PARAMETERS** list and the **AUTOMATIC COMMAND MODE** (Function Generator) are only accessible with a password and intended to be used by application engineers only. The L180GUI version 2.0 when used together with firmware A2 (C08500-002) the **AUTOMATIC COMMAND MODE** is accessible and the **PRIVILEGED PARAMETERS** remain password protected.

### 5.4.13 SOFTWARE DRIVE RESET

The drive can be reset by the **RESET** button or the menu item **RESET DRIVE** in the **UTILITIES** menu. The shortcut for this function is **SHIFT+F7**.

### 5.4.14 SOFTWARE PREFERENCES

The **SOFTWARE PREFERENCES** dialog box is accessible with its menu item on the **CONFIGURATION** menu. The limited parameter set uploads only parameters which are motor specific. The full list uploads all read/write parameters and important drive informations.

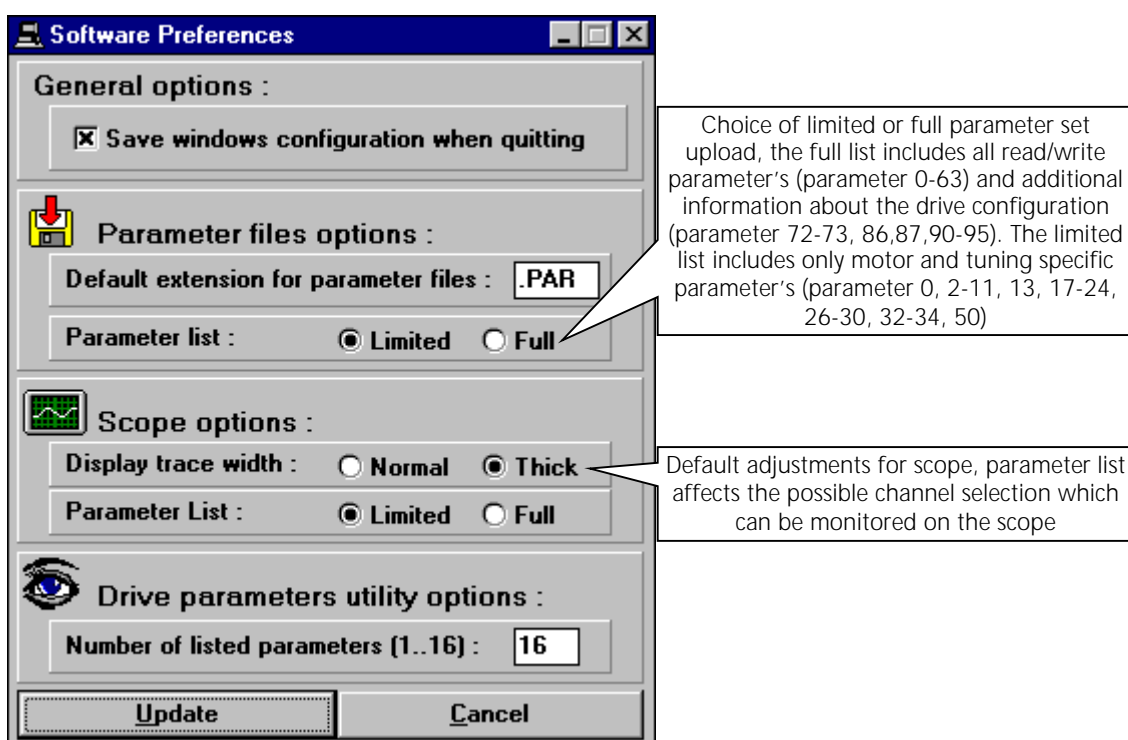

Figure 75: Preferences

#### 5.4.15 DRIVE AND MOTOR INDICATIONS

The **MOTOR STATUS** indication is accessible as a menu item of the **VIEW** menu. Servo Drive **ALARM** and **STATUS** indication is accessible using the toolbar button or with the menu item on the **VIEW** menu. A green zero indicates regular operation or digital input not activated. One click activates the alarm window, two clicks activates the status window.

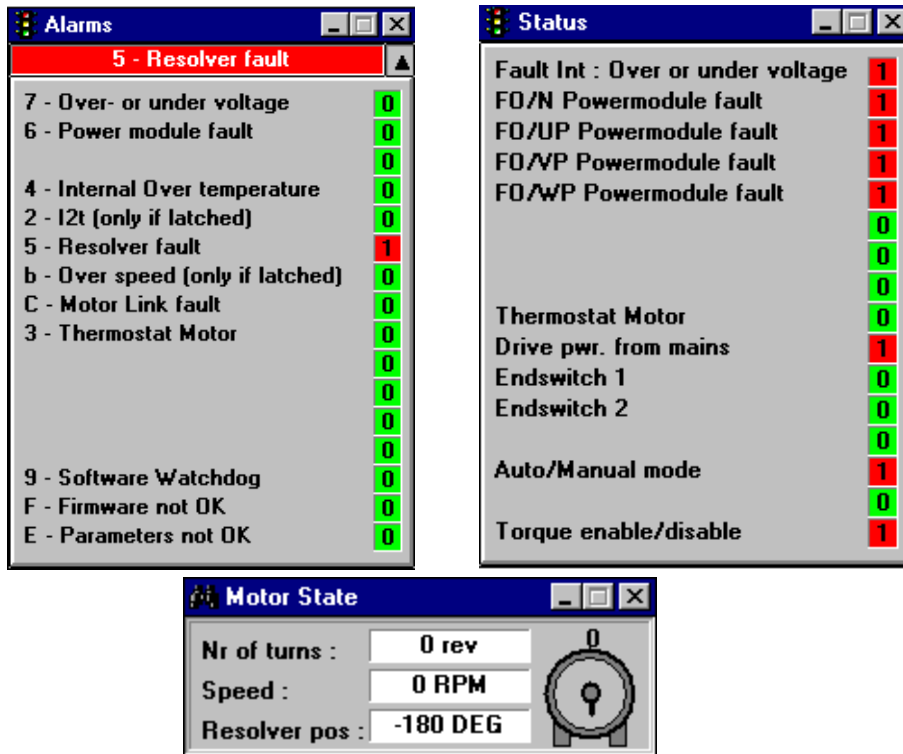

Figure 76: Drive GUI Indications



## 6 SYSTEM DESCRIPTION

### 6.1 SERVO STOP



#### WARNING

The L180 drive does not provide an emergency stop feature. This case must be controlled by higher host computer or PLC. Disabling or disconnecting the drive from the mains causes a free wheeling motor.

If the motor has to be servo-stopped, use the end switches to accomplish this task. This principle is illustrated in Figure 77, below.

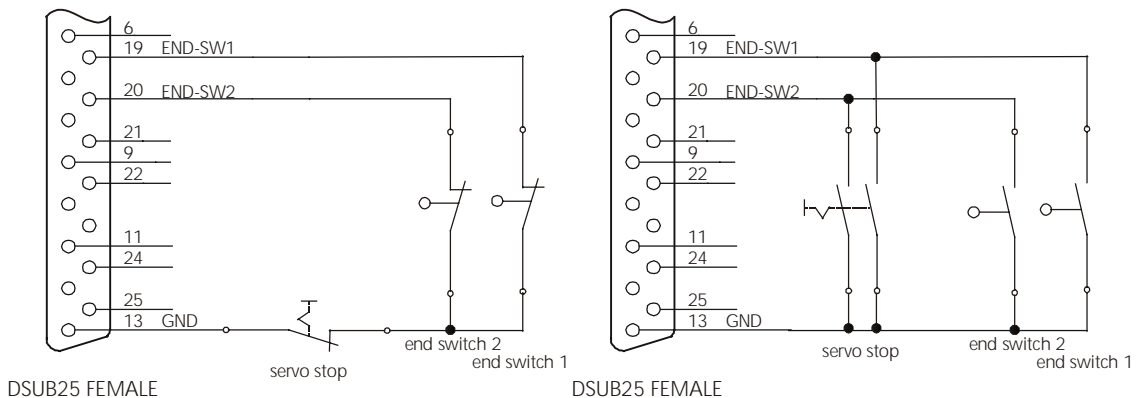

Figure 77: End switch Configuration for servo stop, connector J3

In case of a servo stop the internal command is set to zero or ramped down to zero as programmed.



#### WARNING

The command slope also affects the functionality of the servo stop. If a ramp is programmed, the speed or current will ramp down when a servo stop is activated. This functionality must be reviewed with your application.

## 6.2 DISPLAY INDICATION

### 6.2.1 REGULAR INDICATION

The display shows the status of the drive and of the motor in regular operation.



Drive is ready, drive disabled



Drive is ready, drive disabled, motor/resolver in zero position



Drive enabled



Drive enabled, motor/resolver in zero position



The decimal point is « ON » when the motor turns clockwise, rotation viewed facing the shaft



The decimal point is « OFF » when the motor turns counterclockwise, rotation viewed facing the shaft

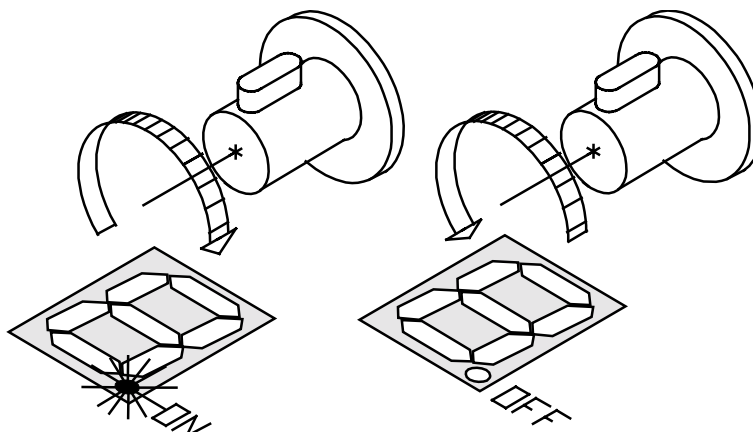

Figure 78: Definition of sense of rotation, viewed from the shaft

If the decimal point is on during counterclockwise rotation, check the resolver wiring (see section 4.2.2).

### 6.2.2 WARNING INDICATION



Over current, appears within 1 sec when 120% of maximum drive current is reached (improper tuning parameters).



If I<sup>2</sup>t is not latched the Warning occurs and reduces the current to the continuous motor current, till the instantaneous I<sup>2</sup>t value is below the limit.

If a warning occurs the drive will keep operating and the monitoring relay will remain closed.



#### 6.2.3 ALARM INDICATION

If two or more alarms occur at the same time, only the alarm with the highest priority will be shown on the seven segment display. The alarm Indication in decreasing order is as follows, H, F, E, d, C, b, 9, 7, 6, 5, 4, 3, 2. If one of the following failures occur during operation, the L180 drive will be disabled and the motor will coast to a stop.

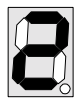

##### I<sup>2</sup>t

I<sup>2</sup>t limit achieved, if this failure is latched.

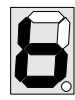

##### Over speed

When 120% of maximum programmed motor speed is achieved. This failure is latched.

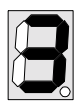

##### Motor temperature

Motor temperature is over 155°C, NTC resistor value is below 4.2 kΩ.



##### Motor connection

Motor wiring is broken or disconnected.



##### Internal Overtemperature

The internal heatsink temperature is above 80°C.



##### Overvoltage

The DC-BUS voltage is above the limits. The alarm occurs when over-, undervoltage alarm is unlatched.



##### Resolver fault

Resolver signals lost, due to broken wire or disconnection.



##### Parameter

Insufficient Parameters, wrong checksum of stored parameter.

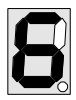

##### Power module fault

The power module fault occurs in any case of short circuit.

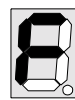

##### Firmware

Firmware is incomplete, only after an update of the firmware.



##### Over-, Undervoltage

The DC-BUS voltage is above or below the limits.



##### Hardware (blinking)

Firmware is incompatible with the hardware.

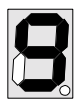

##### Watchdog

Serial communication is out of time. Occurs only if watchdog time is adjusted different than 0.

#### 6.2.4 ALARM HANDLING

If an alarm is unlatched and the failure occurs the monitoring relay will open.



### WARNING

The drive will return to operation immediately upon removal the failure without resetting the drive. Special care must be taken in this situation.

In speed mode the drive performs a servo stop if I<sup>2</sup>t, motor overtemperature, internal overtemperature, or watchdog alarm occur. In all other cases the drive perform a coast stop. In speed mode the internal command is set to zero and if speed is below 20 rpm the drive is disabled.

In current mode the drive is disabled and the motor performs a coast stop in all cases.

#### 6.2.5 MONITORING RELAY – ENABLE TIMING

The following plots show some detailed information about the timing of the monitoring relay and the operation of the power module. The status of the relay is valid 2.5 s after power up of the servo drive.

The drive when used together with the A1 (C08500-001) firmware behaves like the following Figure 79 - Figure 80.

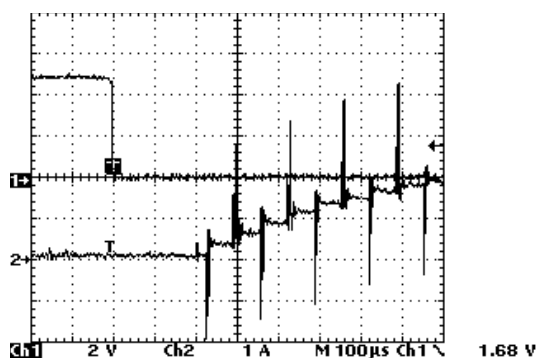

Channel 1: drive enable on pin J3:12 – 13,  
high(5VDC) = disable, low (0VDC) = enable  
Channel 2: motor phase current

Figure 79: A1 firmware operation power module

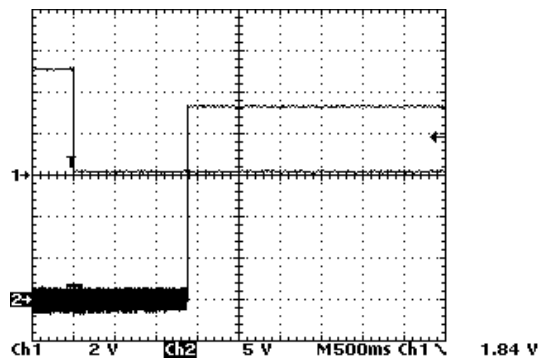

Channel 1: drive enable on pin J3:12 – 13  
high(5VDC) = disable, low (0VDC) = enable  
Channel 2: monitoring relay

Figure 80: A1 firmware Monitoring relay

In Figure 79 the drive is ready to be enabled and no fault has occurred the power module is set into operation within 300µs. The time is constant and no time jitter must be expected.

In Figure 80 a fault has occurred and shows the time required to reset the drive and close the monitoring relay. The time is constant 1.5 s and no time jitter must be expected.

The drive when used together with the A2 (C08500-002) firmware behaves like the following Figure 81 – Figure 82.

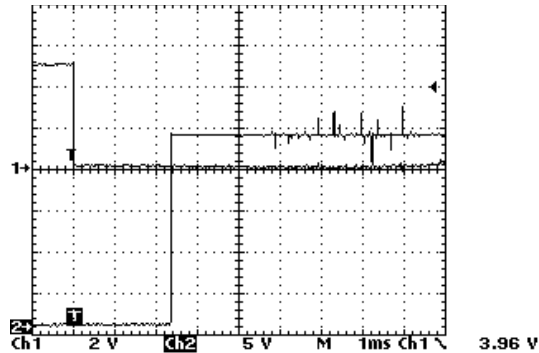

Channel 1: drive enable on pin J3:12 – 13,  
high(5VDC) = disable, low (0VDC) = enable  
Channel 2: monitoring relay

*Figure 81: A2 firmware Monitoring relay*

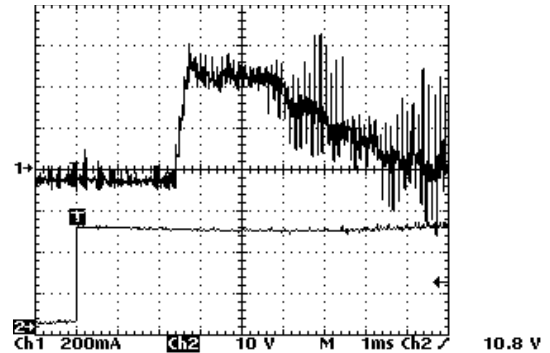









Channel 1: motor phase current  
Channel 2: monitoring relay







*Figure 82: A2 firmware operation power module*

In Figure 81 a fault has occurred and shows the time (500 $\mu$ s to 3ms) required to reset the drive and close the monitoring relay. The timing is not constant and a time jitter must be expected from 500 $\mu$ s to 3ms.

In Figure 82 a fault has occurred and shows the time required to set the power module in operation after closing the monitoring relay. The time is constant 2.5 ms and no time jitter must be expected.

## 6.3 TROUBLE SHOOTING GUIDE

Indication	Check, Correction
	<p><b>I<sup>2</sup>t alarm</b></p> <ul style="list-style-type: none"> <li>• I<sup>2</sup>t time is insufficient or motor is overloaded.</li> <li>• Resolver wiring is incorrect.</li> <li>• Motor wiring U(A), V(B), W(C) on terminal TB1 is in incorrect order.</li> <li>• Motor brake is not released.</li> </ul>
	<p><b>Motor temperature alarm</b></p> <ul style="list-style-type: none"> <li>• Motor is overloaded.</li> <li>• Short circuit on motor temperature sensor or wiring.</li> <li>• Wrong adjustment of the motor thermostat parameter.</li> </ul>
	<p><b>Internal Overtemperature</b></p> <ul style="list-style-type: none"> <li>• Drive is overloaded.</li> <li>• Drive cooling deficient.</li> <li>• Continuous regeneration power is to high.</li> </ul>
	<p><b>Resolver fault.</b></p> <ul style="list-style-type: none"> <li>• Resolver wiring or connection failure.</li> <li>• Resolver failure.</li> </ul>
	<p><b>Power module fault</b></p> <ul style="list-style-type: none"> <li>• Short circuit between motor phases.</li> </ul>
	<p><b>Over-, Undervoltage</b></p> <ul style="list-style-type: none"> <li>• Main supply input voltage L1, L2 and L3 is to low.</li> <li>• Maximum regeneration power is to high.</li> </ul>
	<p><b>Watchdog</b></p> <ul style="list-style-type: none"> <li>• Serial communication is out of time.</li> <li>• Serial communication is broken.</li> </ul>
	<p><b>Over current fault</b></p> <ul style="list-style-type: none"> <li>• Current regulation parameters are deficient.</li> <li>• Main supply input voltage L1, L2 and L3 is to low.</li> </ul>

Indication	Check, Correction
	<p><b>Over speed</b></p> <ul style="list-style-type: none"> <li>• Motor is driven by external load.</li> <li>• Load insufficient to limit motor speed (current loop only).</li> </ul>
	<p><b>Motor connection</b></p> <ul style="list-style-type: none"> <li>• Motor connection failure due to broken wire.</li> <li>• Motor connector does not fit exactly to the mating connector.</li> </ul>
	<p><b>Overvoltage</b></p> <ul style="list-style-type: none"> <li>• Maximum regeneration power is too high.</li> <li>• Over-, Undervoltage alarm is unlatched.</li> </ul>
	<p><b>Parameter</b></p> <ul style="list-style-type: none"> <li>• Check parameter and resave.</li> </ul>
	<p><b>Firmware</b></p> <ul style="list-style-type: none"> <li>• Reload latest firmware, Monitor program is always operating even with incomplete Firmware.</li> </ul>
 <p>blinking</p>	<p><b>Hardware</b></p> <ul style="list-style-type: none"> <li>• The firmware is incompatible with drive hardware.</li> </ul>

### 6.3.1 DRIVE RESET

All failures can be reset by the drive enable except the power module failure. In case of this the main input voltage must be switched off as long as the DC-BUS capacitors are charged.

For firmware A1 (C08500-001) the first enable resets the drive faults, a second enable is necessary to reset the power module. Therefore if only one failure was present two enable cycles are necessary.

For firmware A2 (C08500-002) the reset is done with one enable transition. The drive operates if no other failure is present.

Otherwise the next failure with the highest priority will be displayed until all failures are fixed.

### 6.3.2 OTHER PROBLEM SOURCES

Trouble	Check, Correction
Seven segment display indicates an operating drive (0) but the motor does not turn when a analog command is applied.	<ul style="list-style-type: none"> <li>• End switch configuration is incorrect</li> <li>• End switches are activated</li> <li>• MANUAL mode is activated</li> <li>• Motor brake is not released</li> <li>• Drive is in digital mode</li> </ul>
Motor stays locked into a position	<ul style="list-style-type: none"> <li>• Pair of motor poles is incorrect</li> <li>• Motor wiring U(A), V(B), W(C) on terminal TB1 is in incorrect order</li> <li>• Resolver wiring is incorrect</li> </ul>
Motor makes noise	<ul style="list-style-type: none"> <li>• Resolver cable routing and wiring is deficient</li> <li>• Earth link is broken</li> </ul>
Serial communication is down, L180GUI indicates offline status	<ul style="list-style-type: none"> <li>• Serial cable is broken or disconnected</li> <li>• Serial port of the PC is wrong</li> </ul>
Firmware upgrade cannot be performed	<ul style="list-style-type: none"> <li>• Serial communication is down</li> </ul>

In any case of uncertainty about the drive behavior or trouble shooting please do not hesitate to contact your local MOOG application engineer.

## 6.4 FAILURE REPORT

If repair of a servo drive should prove necessary, all parts not fitted by Moog should be removed. A detailed failure or breakdown report is appreciated. The draft below can be used as a guideline. **"FOR REPAIR"** should be clearly stated on the delivery note. The drive should be packed so as to avoid transportation damage. A defective drive is to be returned to your local subsidiary.

### General Data:

Customer:		Examiner:	
Part No.:		Date of examination:	
Serial No.:			

### Failure Description:

---



---



---



---



---

### Visual Inspection:

	Failure		Failure
Mechanical damages		Drive incomplete	
Wiring		Fuses	

### Technical Inspection:

	Failure		Failure		Failure
24 VDC only drive boot	<input type="checkbox"/>	Drive Enable	<input type="checkbox"/>	Over voltage	<input type="checkbox"/>
230VAC only drive boot	<input type="checkbox"/>	Auto/Manual	<input type="checkbox"/>	Encoder Signal	<input type="checkbox"/>
J5 ± 15 VDC Output	<input type="checkbox"/>	Endswitch 1	<input type="checkbox"/>	Analog Input	<input type="checkbox"/>
Parameter download	<input type="checkbox"/>	Endswitch 2	<input type="checkbox"/>	Power Module	<input type="checkbox"/>
Monitoring Relay	<input type="checkbox"/>	Motor Thermistor	<input type="checkbox"/>	Serial Port	<input type="checkbox"/>

### Drive Indication (seven segment display):

---

# MOOG



<b>Australia</b>	Melbourne
<b>Brazil</b>	São Paulo
<b>China</b>	Hong Kong
<b>China</b>	Shanghai
<b>Denmark</b>	Copenhagen
<b>England</b>	Tewkesbury
<b>Finland</b>	Espoo
<b>France</b>	Rungis
<b>Germany</b>	Boeblingen
<b>India</b>	Bangalore

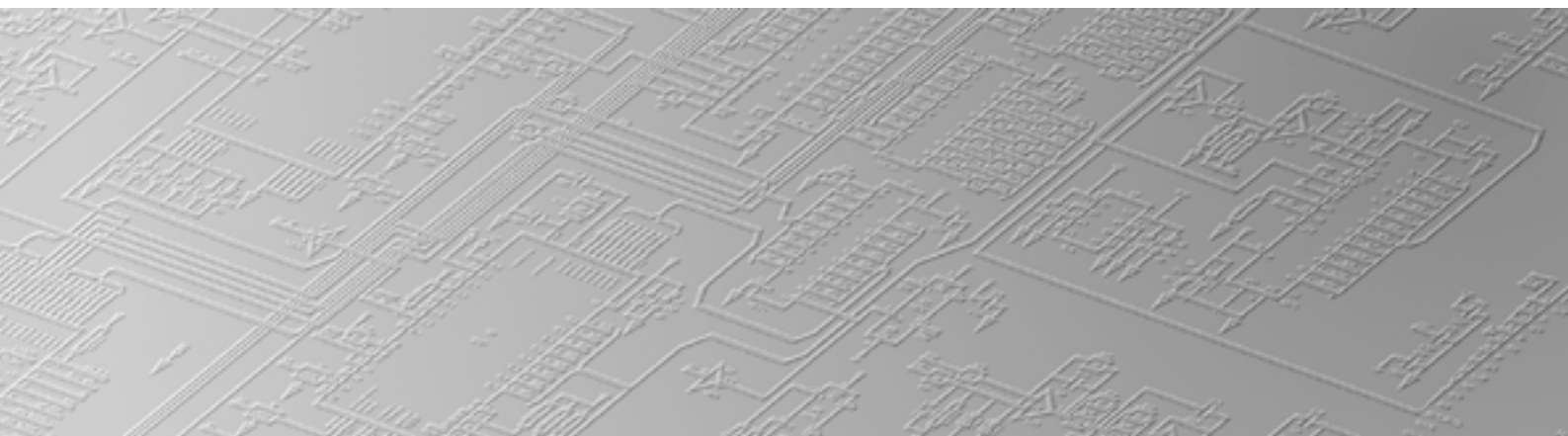

<b>Ireland</b>	Ringaskiddy
<b>Italy</b>	Brescia
<b>Italy</b>	Malnate
<b>Japan</b>	Hiratsuka
<b>Korea</b>	Kwangju
<b>Luxembourg</b>	Luxembourg
<b>Philippines</b>	Baguio
<b>Singapore</b>	Singapore
<b>Spain</b>	Orio
<b>Sweden</b>	Gotenborg
<b>USA</b>	East Aurora

H/O / Technical changes are reserved

MOOG GmbH  
Hanns-Klemm-Straße 28  
71034 Boeblingen  
Postfach 1670  
71006 Boeblingen  
GERMANY  
Phone: +49(0) 7031 622-0  
Fax: +49(0) 7031 622-100  
e-mail: sales@moog.de  
internet: www.moog.com



C08476-001 Rev c

**L180 - MA / 05.01**