

BN28 Specifications

Inside Rotor
Brushless Motors

BN28 SPECIFICATIONS -

*Continuous Stall Torque 43 - 108 oz-in (0.30 - 0.76 Nm)
Peak Torque 188 - 737 oz-in (1.33 - 5.2 Nm)*

Part Number*		BN28-21AF- <input type="checkbox"/> <input type="checkbox"/> <input type="checkbox"/> <input type="checkbox"/> <input type="checkbox"/> <input type="checkbox"/>			BN28-29AF- <input type="checkbox"/> <input type="checkbox"/> <input type="checkbox"/> <input type="checkbox"/> <input type="checkbox"/> <input type="checkbox"/>			BN28-36AF- <input type="checkbox"/> <input type="checkbox"/> <input type="checkbox"/> <input type="checkbox"/> <input type="checkbox"/> <input type="checkbox"/>			BN28-44AF- <input type="checkbox"/> <input type="checkbox"/> <input type="checkbox"/> <input type="checkbox"/> <input type="checkbox"/> <input type="checkbox"/>		
Winding Code**		01	02	03	01	02	03	01	02	03	01	02	03
L = Length	inches	2.10			2.90			3.60			4.40		
	millimeters	53.3			73.7			91.4			111.8		
Terminal Voltage	volts DC	24.0	48.0	72.0	24.0	48.0	72.0	24.0	48.0	72.0	24.0	48.0	72.0
Peak Torque	oz-in	188.0	188.0	188.0	407.0	407.0	407.0	596.0	596.0	596.0	737.0	737.0	737.0
	Nm	1.3276	1.3276	1.3276	2.8740	2.8740	2.8740	4.2087	4.2087	4.2087	5.2043	5.2043	5.2043
Continuous Stall Torque	oz-in	43.0	44.0	46.0	71.0	74.0	72.0	93.0	95.0	93.0	106.0	108.0	105.0
	Nm	0.3036	0.3107	0.3248	0.5014	0.5226	0.5084	0.6567	0.6708	0.6567	0.7485	0.7626	0.7415
Rated Speed	RPM	9170	9230	9240	8870	8900	7890	5890	5910	5230	4660	4680	4120
	rad/sec	960	967	968	929	932	826	617	619	548	488	490	431
Rated Torque	oz-in	31	31	33	40	40	46	68	70	72	84	84	86
	Nm	0.2189	0.2189	0.2330	0.2825	0.2825	0.3248	0.4802	0.4943	0.5084	0.5932	0.5932	0.6073
Rated Current	Amps	10.26	5.13	3.63	12.67	6.33	4.29	14.31	7.35	4.51	14.25	7.13	4.35
Rated Power	watts	210.3	211.6	225.5	262.4	263.3	268.4	296.2	306.0	278.5	289.5	290.8	262.1
Torque Sensitivity	oz-in/amp	3.24	6.49	9.73	3.48	6.95	11.59	5.07	10.13	16.89	6.25	12.50	20.84
	Nm/amp	0.0229	0.0458	0.0687	0.0246	0.0491	0.0818	0.0358	0.0715	0.1193	0.0441	0.0883	0.1472
Back EMF	volts/KRPM	2.40	4.80	7.20	2.57	5.14	8.57	3.75	7.49	12.49	6.79	9.24	15.41
	volts/rad/sec	0.0229	0.0458	0.0687	0.0246	0.0491	0.0818	0.0358	0.0715	0.1193	0.048	0.0883	0.1472
Terminal Resistance	ohms	0.14	0.51	1.08	0.087	0.25	0.72	0.10	0.36	1.05	0.147	0.47	1.38
Terminal Inductance	mH	0.18	0.72	1.62	0.11	0.43	1.19	0.17	0.69	1.92	0.24	0.97	2.69
Motor Constant	oz-in/sq.rt.watt	8.72	9.06	9.38	13.44	13.93	13.69	16.45	16.86	16.49	17.82	18.18	17.73
	Nm/sq.rt.watt	0.062	0.064	0.066	0.095	0.098	0.097	0.116	0.119	0.11645	0.12584	0.12835	0.12518
Rotor Inertia	oz-in-sec ² x10 ⁻³	2.30	2.30	2.30	4.40	4.40	4.40	6.60	6.60	6.60	8.80	8.80	8.80
	g-cm ²	162.3	162.3	162.3	310.5	310.5	310.5	465.8	465.8	465.8	621.0	621.0	621.0
Weight	oz	23.0	23.0	23.0	35.0	35.0	35.0	48.0	48.0	48.0	61.0	61.0	61.0
	g	653.2	653.2	653.2	994.0	994.0	994.0	1363.2	1363.2	1363.2	1732.4	1732.4	1732.4
# of Poles		8.0	8.0	8.0	8.0	8.0	8.0	8.0	8.0	8.0	8.0	8.0	8.0
Timing		120°	120°	120°	120°	120°	120°	120°	120°	120°	120°	120°	120°
Mech. Time Constant	ms	4.3	4.0	3.7	3.4	3.2	3.3	3.5	3.3	3.4	3.9	3.8	4.0
Electrical Time Constant	ms	1.30	1.40	1.51	1.64	1.73	1.66	1.79	1.91	1.83	1.95	2.05	1.95
Thermal Resistivity	deg. C/watt	2.9	3.0	2.9	2.5	2.6	2.6	2.2	2.2	2.3	2.0	2.0	2.1
Speed/Torque Gradient	rpm/oz-in	47	47	47	25	25	25	20	20	20	13	13	13

Notes:

- Motor mounted to a 10 x 10 x 1/4 inches aluminum plate, still air.
- Maximum winding temperature of 155°C.
- Typical electrical specifications at 25°C.
- Motor Terminal Voltages are representative only; motors may be operated at voltages other than those listed in the table. For assistance please contact our applications engineer.
- For MS (military style) connector, please specify connector housing and terminal.
- Data for informational purposes only. Should not be considered a binding performance agreement. For specific applications, please contact the factory.

*Many other custom mechanical options are available – consult factory.

**Many other winding options are available – consult factory.

Select your options below and place their code in its corresponding block as shown on page 5.

- | | | |
|---|--|---|
| <input type="checkbox"/> TERMINATION | <input type="checkbox"/> FEEDBACK OPTIONS | <input type="checkbox"/> OTHER OPTIONS |
| L – Leads (std) | H – Hall Effect (std) | E – Encoder |
| C – Connector | R – Resolver | G – Gearhead |
| M – MS connector | S – Sensorless | |

BN28 Housed / Frameless

Inside Rotor
Brushless Motors

BN28 Typical Outline - Housed

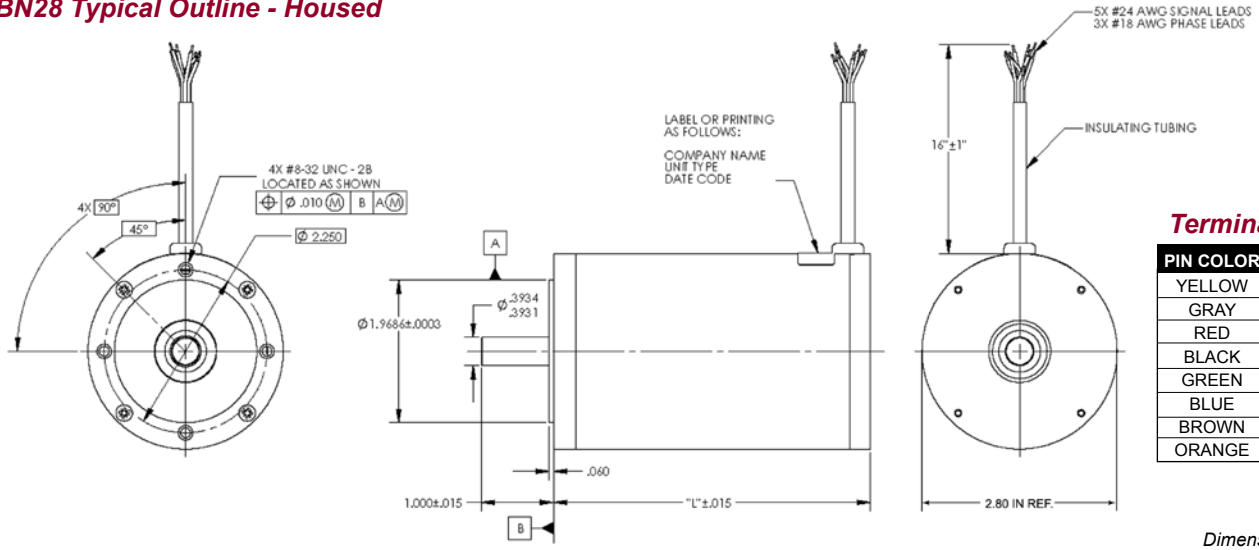

Termination Table

PIN COLOR	CONNECTION
YELLOW	V _{CC}
GRAY	GROUND
RED	A COIL
BLACK	B COIL
GREEN	C COIL
BLUE	S2 OUT
BROWN	S1 OUT
ORANGE	S3 OUT

Dimensions are in inches

BN28 Typical Outline - Frameless

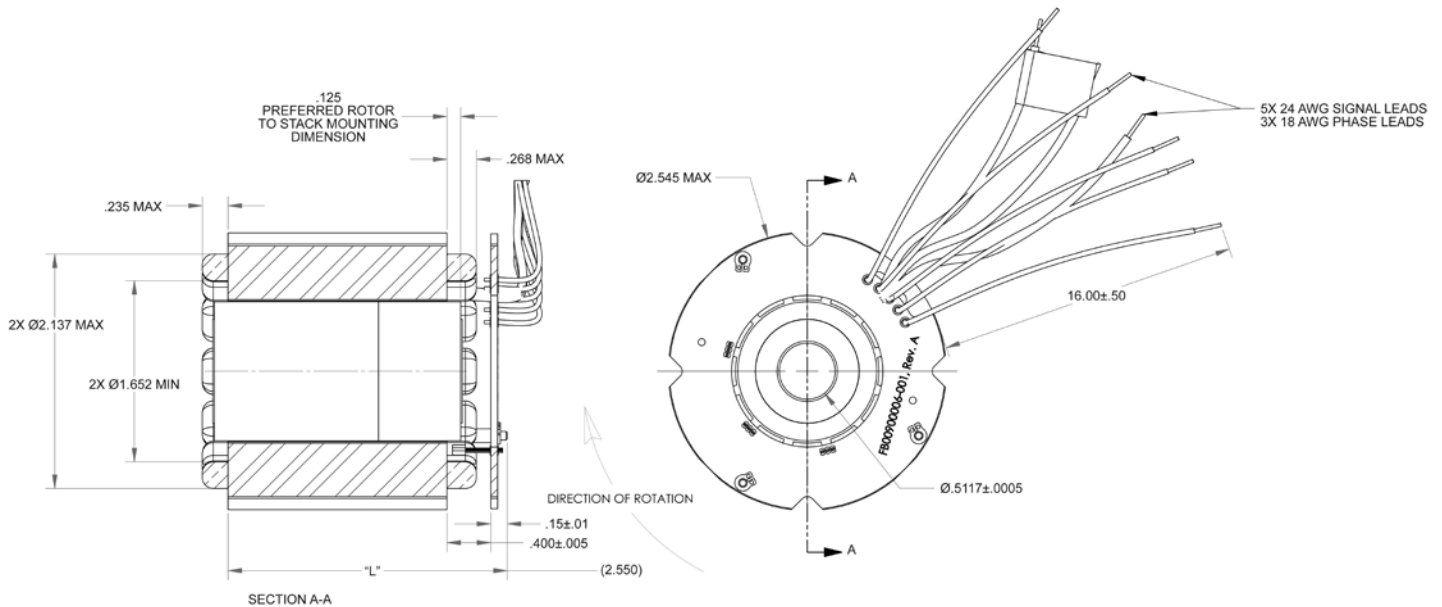

PART NUMBER	"L"
BN28-21ZP-XXLH	1.050
BN28-29ZP-XXLH	1.80
BN28-36ZP-XXLH	2.550
BN28-44ZP-XXLH	3.300

Note: For electrical performance see page 24.

Dimensions are in inches

BN28 Performance Curves

BN28 Performance Curves

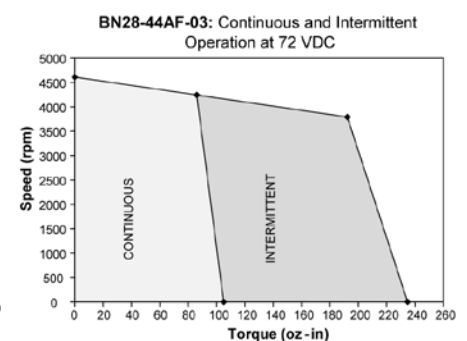
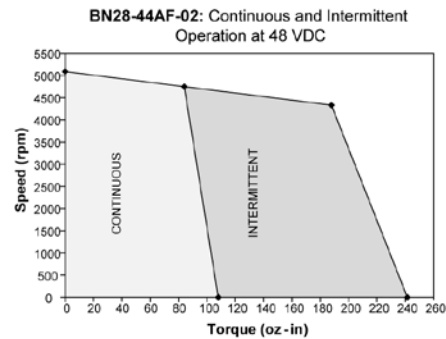
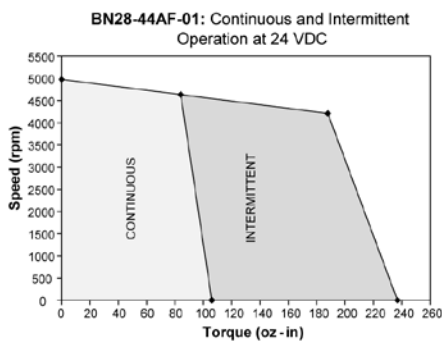
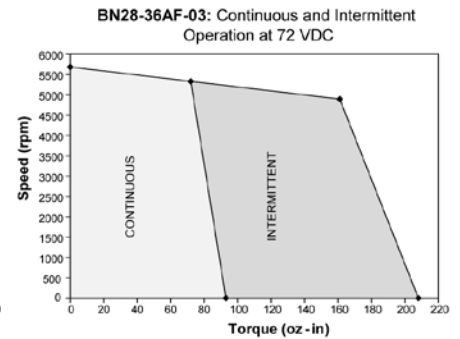
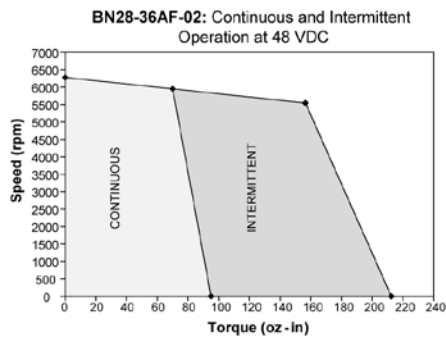
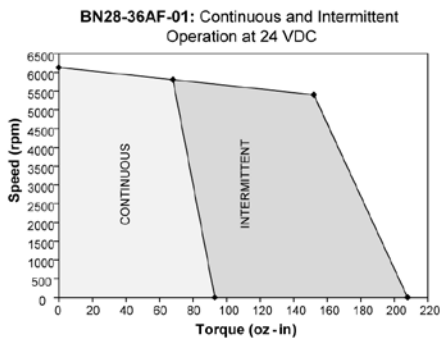
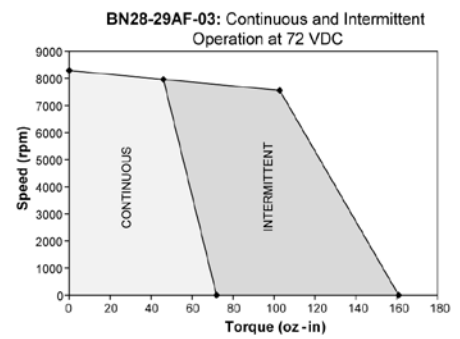
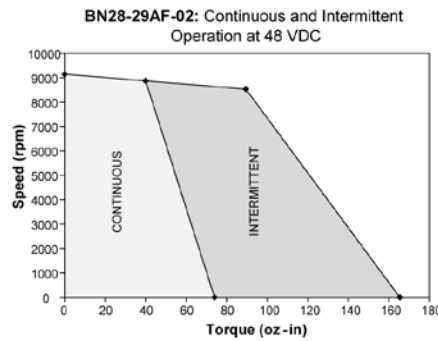
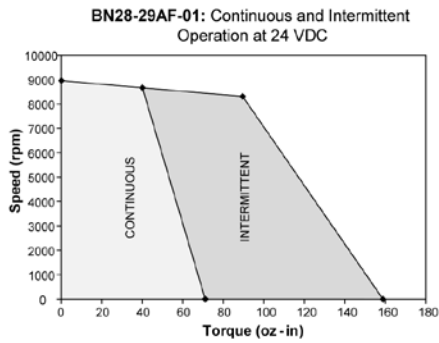
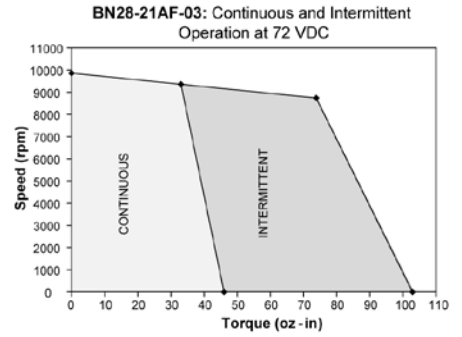
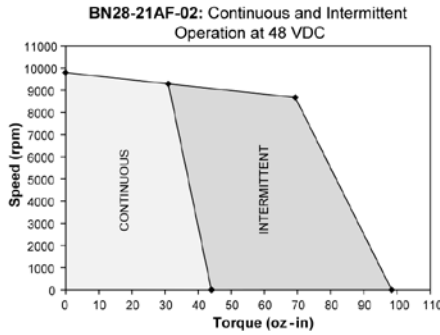
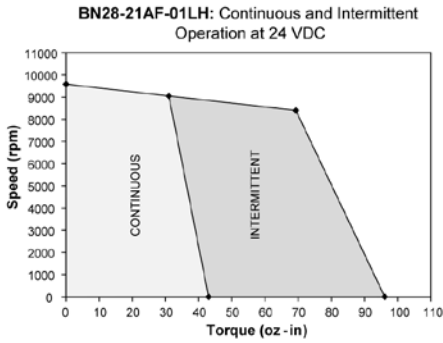

Note: Intermittent operation is based on a 20% duty cycle of one minute on, four minutes off. Please contact the factory regarding the duty cycle of your application.

BN28 IP65 Specifications

BN28 IP65 SPECIFICATIONS - Continuous Stall Torque 43 - 108 oz-in (0.30 - 0.76 Nm)
Peak Torque 188 - 737 oz-in (1.33 - 5.2 Nm)

Inside Rotor
Brushless Motors

Part Number*		BN28-21IP - <input type="checkbox"/> <input type="checkbox"/> <input type="checkbox"/> <input type="checkbox"/> <input type="checkbox"/> <input type="checkbox"/>			BN28-29IP - <input type="checkbox"/> <input type="checkbox"/> <input type="checkbox"/> <input type="checkbox"/> <input type="checkbox"/> <input type="checkbox"/>			BN28-36IP - <input type="checkbox"/> <input type="checkbox"/> <input type="checkbox"/> <input type="checkbox"/> <input type="checkbox"/> <input type="checkbox"/>			BN28-44IP - <input type="checkbox"/> <input type="checkbox"/> <input type="checkbox"/> <input type="checkbox"/> <input type="checkbox"/> <input type="checkbox"/>		
Winding Code**		01	02	03	01	02	03	01	02	03	01	02	03
L = Length	inches	2.10			2.90			3.60			4.40		
	millimeters	53.3			73.7			91.4			111.8		
Terminal Voltage	volts DC	24.0	48.0	72.0	24.0	48.0	72.0	24.0	48.0	72.0	24.0	48.0	72.0
Peak Torque	oz-in	188.0	188.0	188.0	407.0	407.0	407.0	596.0	596.0	596.0	737.0	737.0	737.0
	Nm	1.3276	1.3276	1.3276	2.8740	2.8740	2.8740	4.2087	4.2087	4.2087	5.2043	5.2043	5.2043
Continuous Stall Torque	oz-in	43.0	44.0	46.0	71.0	74.0	72.0	93.0	95.0	93.0	106.0	108.0	105.0
	Nm	0.3036	0.3107	0.3248	0.5014	0.5226	0.5084	0.6567	0.6708	0.6567	0.7485	0.7626	0.7415
Rated Speed	RPM	9170	9230	9240	8870	8900	7890	5890	5910	5230	4660	4680	4120
	rad/sec	960	967	968	929	932	826	617	619	548	488	490	431
Rated Torque	oz-in	31	31	33	40	40	46	68	70	72	84	84	86
	Nm	0.2189	0.2189	0.2330	0.2825	0.2825	0.3248	0.4802	0.4943	0.5084	0.5932	0.5932	0.6073
Rated Current	Amps	10.26	5.13	3.63	12.67	6.33	4.29	14.31	7.35	4.51	14.25	7.13	4.35
Rated Power	watts	210.3	211.6	225.5	262.4	263.3	268.4	296.2	306.0	278.5	289.5	290.8	262.1
Torque Sensitivity	oz-in/amp	3.24	6.49	9.73	3.48	6.95	11.59	5.07	10.13	16.89	6.79	12.50	20.84
	Nm/amp	0.0229	0.0458	0.0687	0.0246	0.0491	0.0818	0.0358	0.0715	0.1193	0.048	0.0883	0.1472
Back EMF	volts/KRPM	2.40	4.80	7.20	2.57	5.14	8.57	3.75	7.49	12.49	5.02	9.24	15.41
	volts/rad/sec	0.0229	0.0458	0.0687	0.0246	0.0491	0.0818	0.0358	0.0715	0.1193	0.048	0.0883	0.1472
Terminal Resistance	ohms	0.14	0.51	1.08	0.087	0.25	0.72	0.10	0.36	1.05	0.147	0.47	1.38
Terminal Inductance	mH	0.18	0.72	1.62	0.11	0.43	1.19	0.17	0.69	1.92	0.24	0.97	2.69
Motor Constant	oz-in/sq.rt.watt	8.72	9.06	9.38	13.44	13.93	13.69	16.45	16.86	16.49	17.82	18.18	17.73
	Nm/sq.rt.watt	0.062	0.064	0.066	0.095	0.098	0.097	0.116	0.119	0.11645	0.12584	0.12835	0.12518
Rotor Inertia	oz-in-sec ² x10 ⁻³	2.30	2.30	2.30	4.40	4.40	4.40	6.60	6.60	6.60	8.80	8.80	8.80
	g-cm ²	162.3	162.3	162.3	310.5	310.5	310.5	465.8	465.8	465.8	621.0	621.0	621.0
Weight	oz	23.0	23.0	23.0	35.0	35.0	35.0	48.0	48.0	48.0	61.0	61.0	61.0
	g	653.2	653.2	653.2	994.0	994.0	994.0	1363.2	1363.2	1363.2	1732.4	1732.4	1732.4
# of Poles		8.0	8.0	8.0	8.0	8.0	8.0	8.0	8.0	8.0	8.0	8.0	8.0
Timing		120°	120°	120°	120°	120°	120°	120°	120°	120°	120°	120°	120°
Mech. Time Constant	ms	4.3	4.0	3.7	3.4	3.2	3.3	3.5	3.3	3.4	3.9	3.8	4.0
Electrical Time Constant	ms	1.30	1.40	1.51	1.64	1.73	1.66	1.79	1.91	1.83	1.95	2.05	1.95
Thermal Resistivity	deg. C/watt	2.9	3.0	2.9	2.5	2.6	2.6	2.2	2.2	2.3	2.0	2.0	2.1
Speed/Torque Gradient	rpm/oz-in	47	47	47	25	25	25	20	20	20	13	13	13

Notes:

- Motor mounted to a 10 x 10 x 1/4 inches aluminum plate, still air.
- Maximum winding temperature of 155°C.
- Typical electrical specifications at 25°C.
- Motor Terminal Voltages are representative only; motors may be operated at voltages other than those listed in the table. For assistance please contact our applications engineer.
- Calculated (theoretical) speed/torque gradient.
- For MS (military style) connector, please specify connector housing and terminal.
- Data for informational purposes only. Should not be considered a binding performance agreement. For specific applications, please contact the factory.

*Many other custom mechanical options are available – consult factory.
**Many other winding options are available – consult factory.

Select your options below and place their code in its corresponding block as shown on page 5.

- | | | |
|---|--|---|
| <input type="checkbox"/> TERMINATION | <input type="checkbox"/> FEEDBACK OPTIONS | <input type="checkbox"/> OTHER OPTIONS |
| L – Leads (std) | H – Hall Effect (std) | E – Encoder |
| C – Connector | R – Resolver | G – Gearhead |
| M – MS connector | S – Sensorless | |

BN28 IP65 Typical Outline

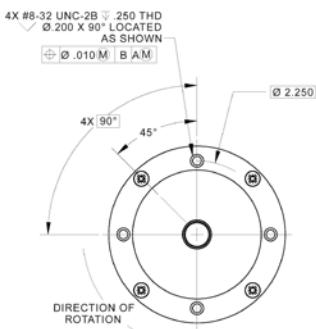

Termination Table

PIN COLOR	CONNECTION
YELLOW	Vcc
GRAY	GROUND
RED	A COIL
BLACK	B COIL
GREEN	C COIL
BLUE	S2 OUT
BROWN	S1 OUT
ORANGE	S3 OUT

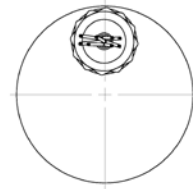
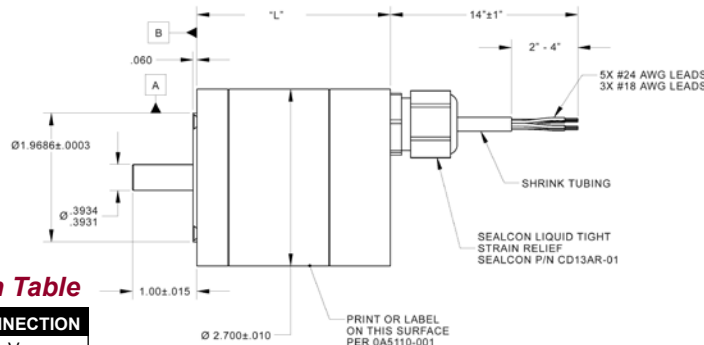

Dimensions are in inches

BN28 IP65 Performance Curves

Inside Rotor
Brushless Motors

BN28 IP65 Performance Curves

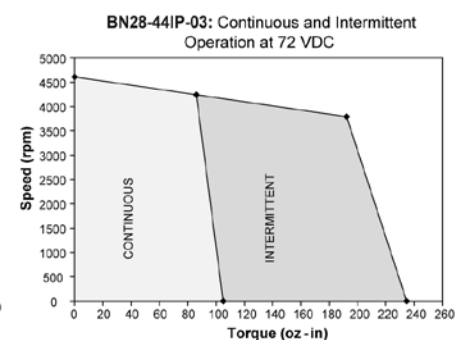
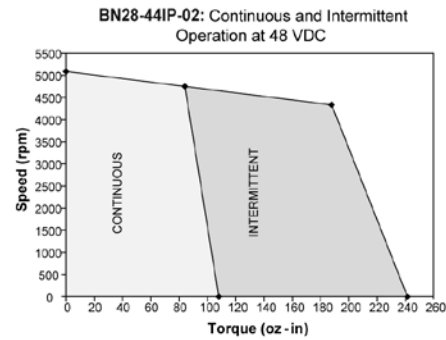
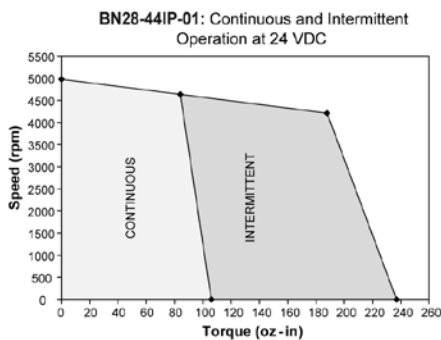
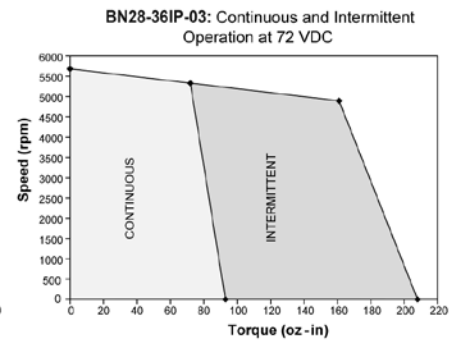
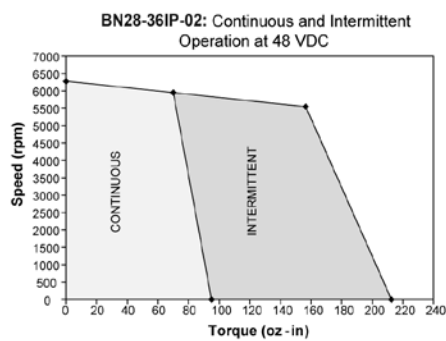
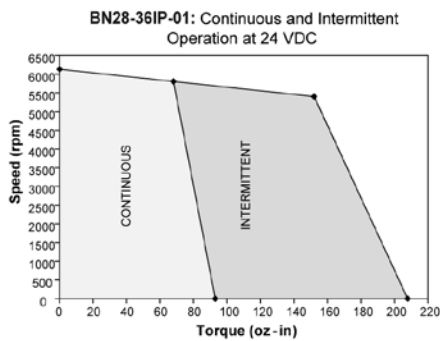
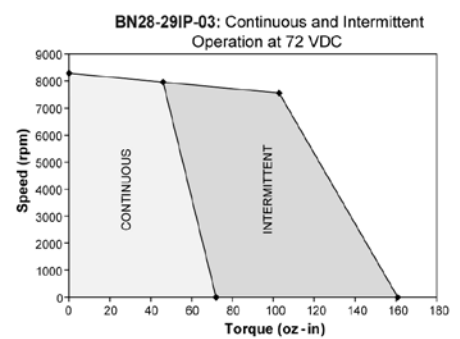
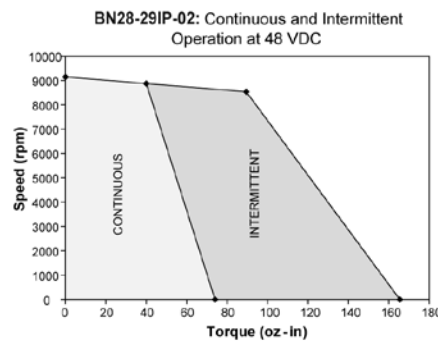
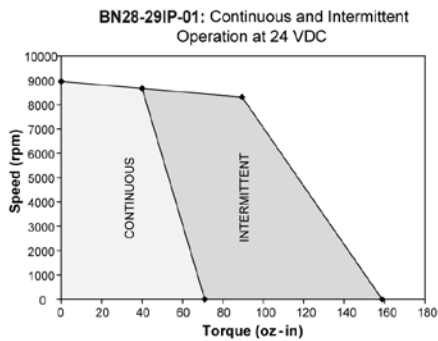
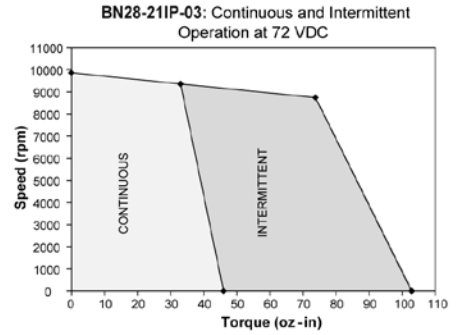
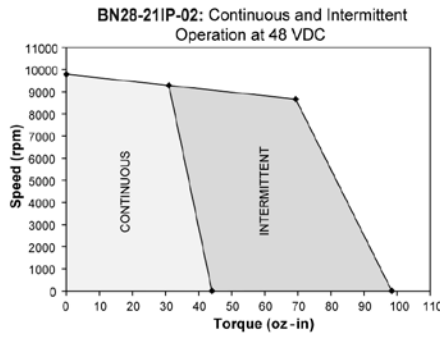
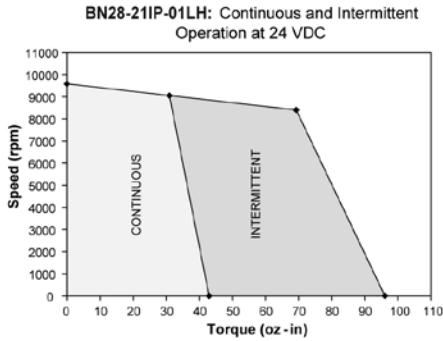

Note: Intermittent operation is based on a 20% duty cycle of one minute on, four minutes off. Please contact the factory regarding the duty cycle of your application.